



GREENWIN

PVC KAPI VE PENCERE SİSTEMLERİ



ÜRÜN KATALOĞU
PRODUCT CATALOG
ПРОДУКТЫ КАТАЛОГ
كتالوج المنتجات

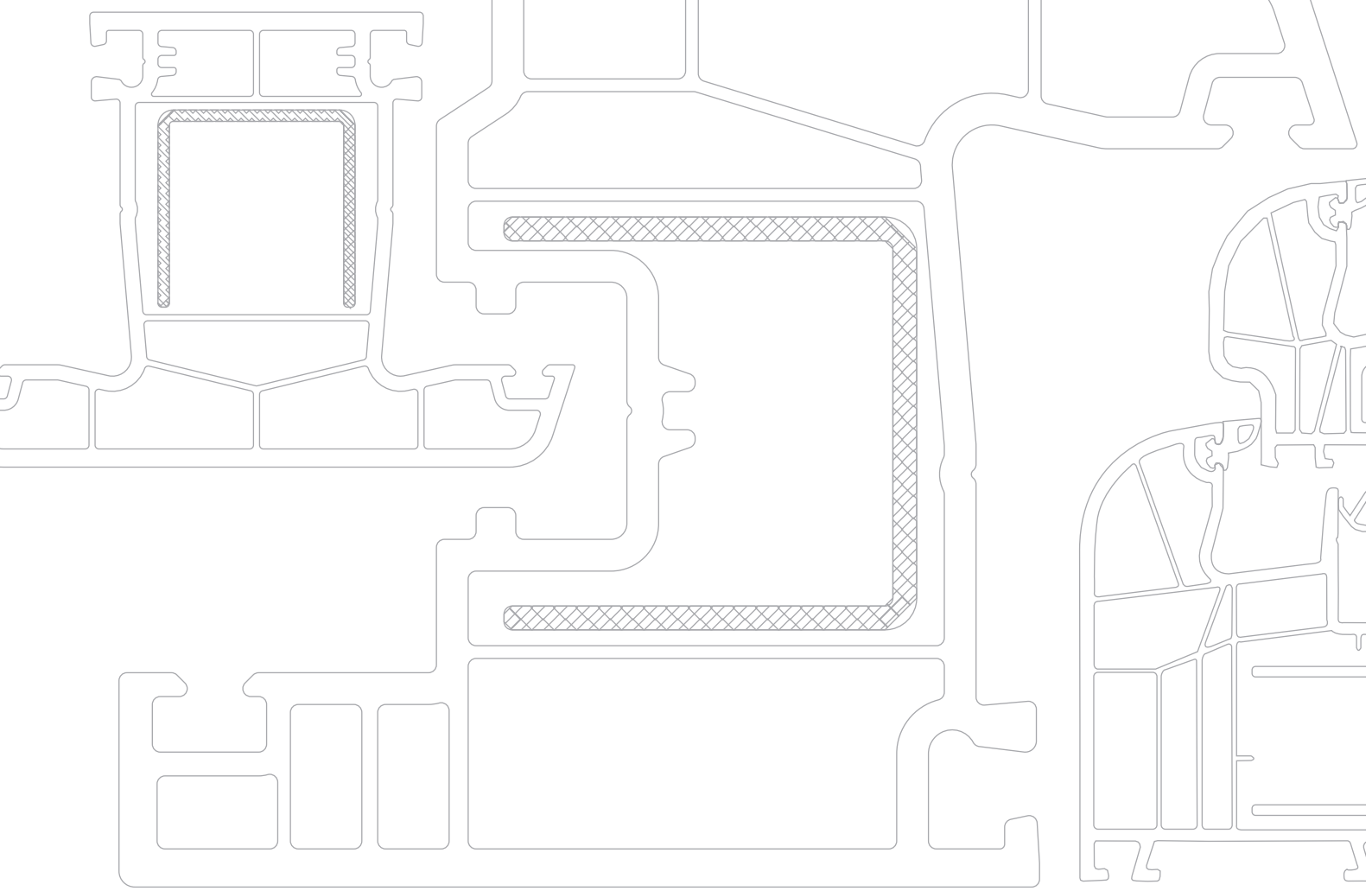

NEHIR

SERISI



GREENWIN

PVC DOOR AND WINDOWS SYSTEM

GR 602101

Kasa Profili

Frame

Pama

بروفيل الاطار

Ağırlık : 980gr/m.

Weight : 980gr/m.

Bec : 980gr/m.

الوزن : ٩٢٠ غم

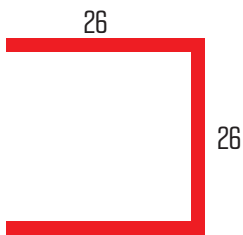
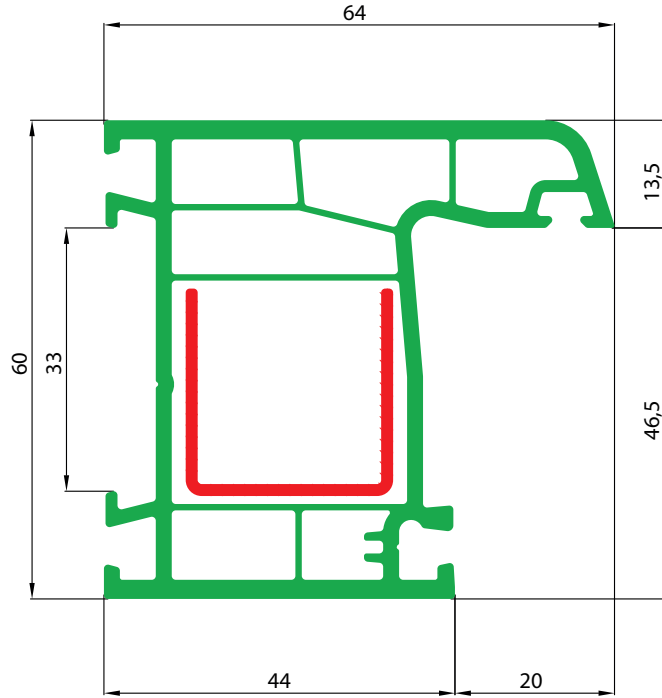
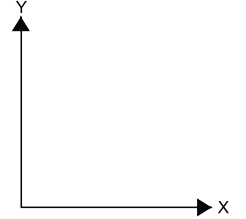

S= 1.20 mm 692 gr/mt $I_x= 1,005 \text{ cm}^4$ $I_y= 0,613 \text{ cm}^4$

S= 1.50 mm 866 gr/mt $I_x= 1,295 \text{ cm}^4$ $I_y= 0,780 \text{ cm}^4$

S= 2.00 mm 1.155 gr/mt $I_x= 1,824 \text{ cm}^4$ $I_y= 1,092 \text{ cm}^4$



GREENWIN

PVC DOOR AND WINDOWS SYSTEM

GR 602102

Kanat Profil	Ağırlık	: 1128 gr/m.
Sash	Weight	: 1128 gr/m.
створка	Bec	: 1128 gr/m.
بروفل الضلقة	الوزن	: ١١٥٠ غم

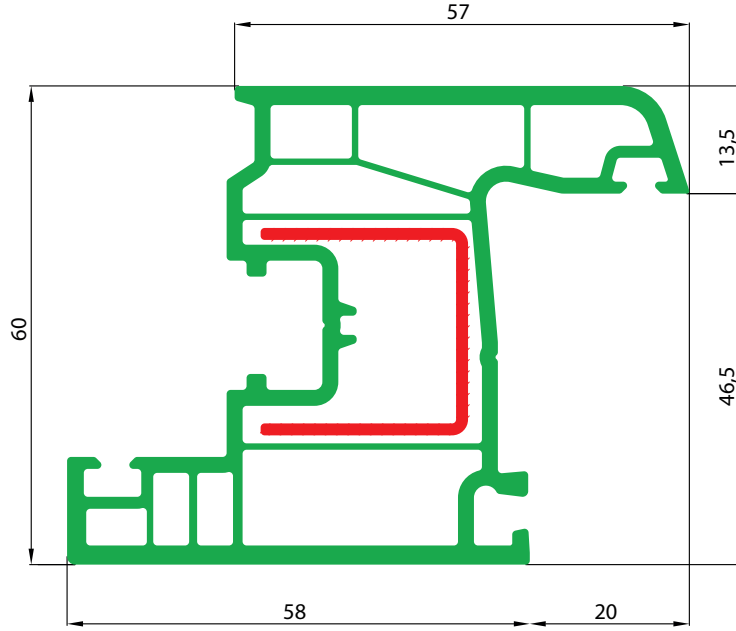
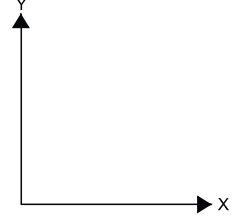

4

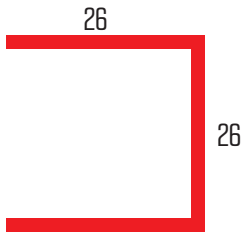

S= 1.20 mm 692 gr/mt $I_x= 1,005 \text{ cm}^4$ $I_y= 0,613 \text{ cm}^4$

S= 1.50 mm 866 gr/mt $I_x= 1,295 \text{ cm}^4$ $I_y= 0,780 \text{ cm}^4$

S= 2.00 mm 1.155 gr/mt $I_x= 1,824 \text{ cm}^4$ $I_y= 1,092 \text{ cm}^4$



GREENWIN

PVC DOOR AND WINDOWS SYSTEM

GR 602103

Ortakayıt Profili
Mullion
Импост
بروفیل تي

Ağırlık : 1111 gr/m.
Weight : 1111 gr/m.
Вес : 1111 gr/m.
الوزن : ۱۱۱۱ غم

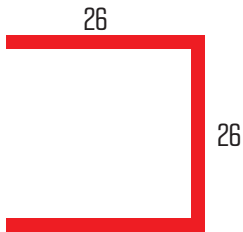
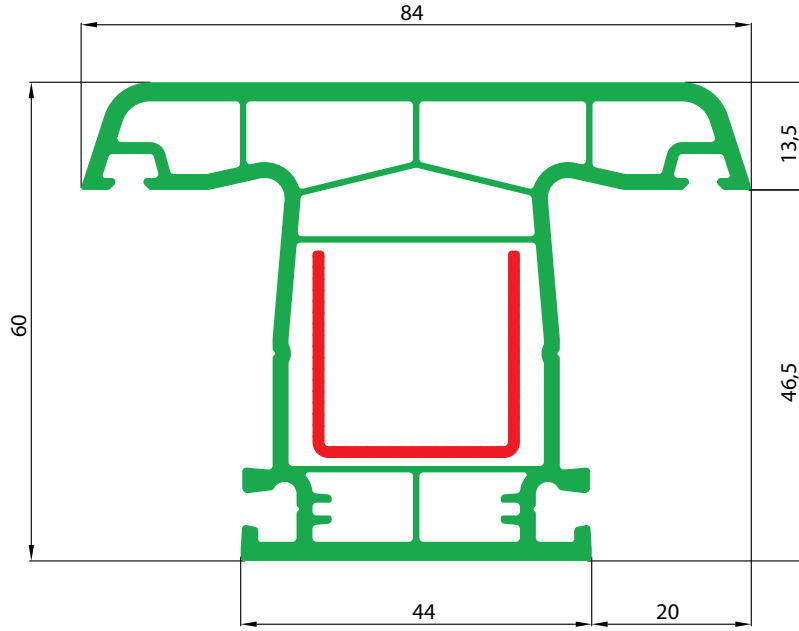
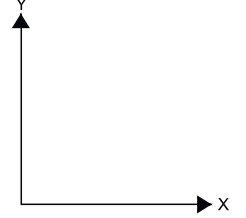

S= 1.20 mm 692 gr/mt Ix= 1,005 cm⁴ Iy= 0,613 cm⁴

S= 1.50 mm 866 gr/mt Ix= 1,295 cm⁴ Iy= 0,780 cm⁴

S= 2.00 mm 1.155 gr/mt Ix= 1,824 cm⁴ Iy= 1,092 cm⁴



GREENWIN

PVC DOOR AND WINDOWS SYSTEM

GR 602104

Pervazlı Kasa Profili
Frame With Cornice Profile
Рама с ОТКОКОМ
بروفیل الاطار بکشف

Ağırlık : 1218 gr/m.
Weight : 1218 gr/m.
Bec : 1218 gr/m.
الوزن : ۱۲۰۰ غم

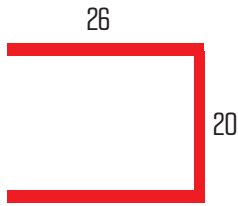
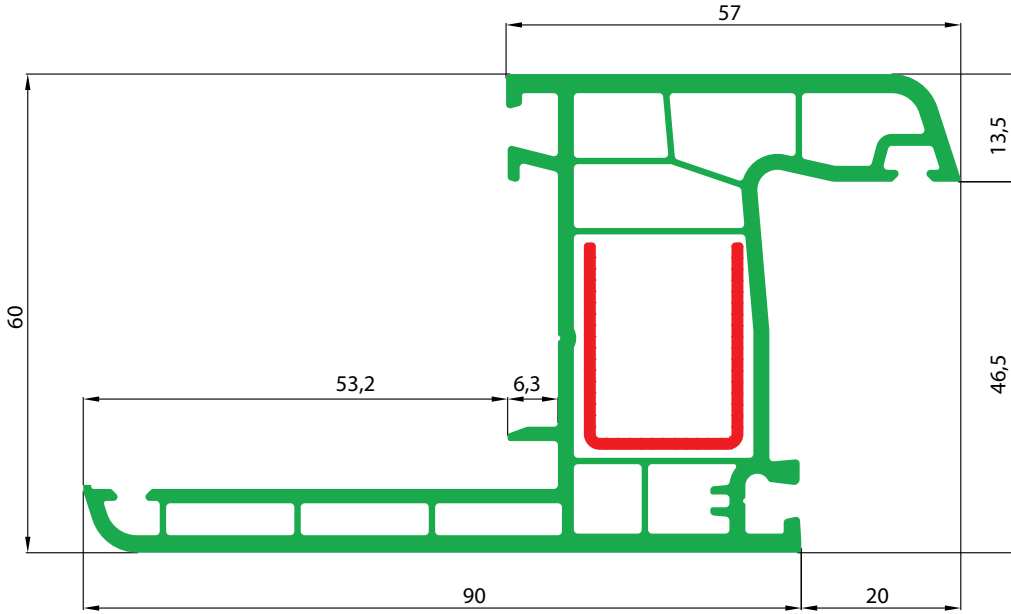
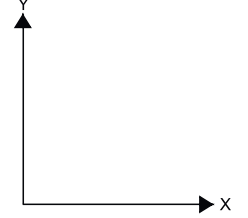

S= 1.20 mm	636 gr/mt	$I_x = 0,549 \text{ cm}^4$	$I_y = 0,556 \text{ cm}^4$
S= 1.50 mm	796 gr/mt	$I_x = 0,713 \text{ cm}^4$	$I_y = 0,707 \text{ cm}^4$
S= 2.00 mm	1.060 gr/mt	$I_x = 1,019 \text{ cm}^4$	$I_y = 0,992 \text{ cm}^4$



GREENWIN

PVC DOOR AND WINDOWS SYSTEM

GR 602105

İçe Açılır Kapı Kanat Profili
In turn Door Sash Profile

дверная створка открытие вовнутрь
بروفيل ضلفة الباب الفتحة الى الداخل

Ağırlık : 1378 gr/m.
Weight : 1378 gr/m.
Вес : 1378 gr/m.
الوزن : ١٣٧٨ غم

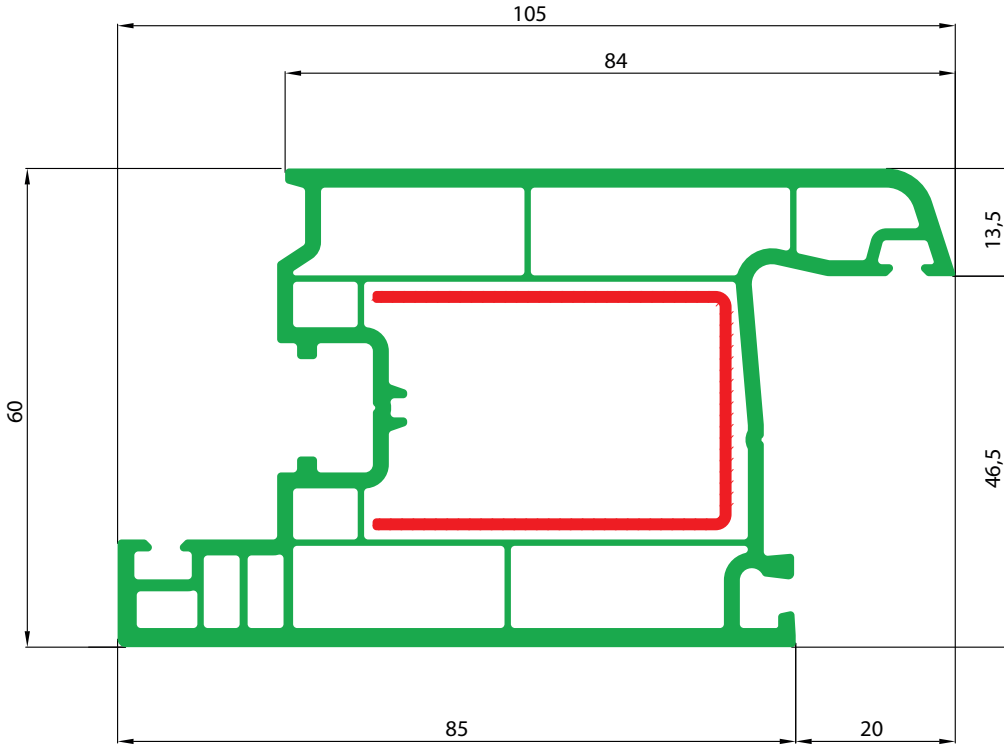
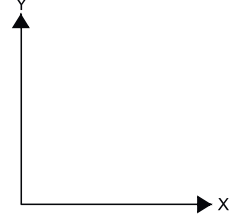

45

30

S= 1.20 mm	1.067 gr/mt	$I_x = 2,919 \text{ cm}^4$	$I_y = 2,304 \text{ cm}^4$
S= 1.50 mm	1.533 gr/mt	$I_x = 3,689 \text{ cm}^4$	$I_y = 2,951 \text{ cm}^4$
S= 2.00 mm	1.778 gr/mt	$I_x = 5,062 \text{ cm}^4$	$I_y = 4,110 \text{ cm}^4$



GREENWIN

PVC DOOR AND WINDOWS SYSTEM

GR 602106

Dıřa Açılır Kapı Kanat Profili
Out Turn Door Sash Profile

дверная створка открытие наружу
بروفیل ضلفة الباب أفتته الى الخأرج

Ađırlık : 1378 gr/m.

Weight : 1378 gr/m.

Вес : 1378 gr/m.

الوزن : ١٣٧٨

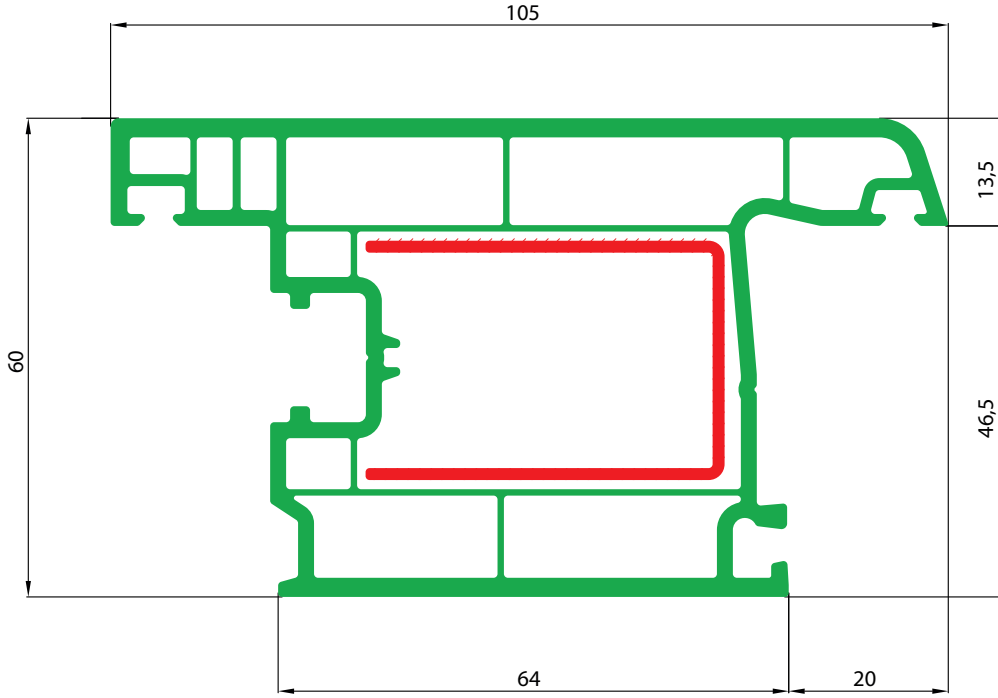
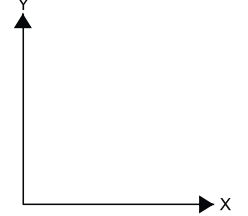

8

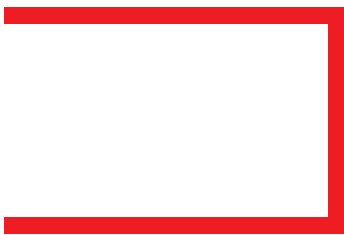

45

30

S= 1.20 mm 1.067 gr/mt $I_x = 2,919 \text{ cm}^4$ $I_y = 2,304 \text{ cm}^4$

S= 1.50 mm 1.533 gr/mt $I_x = 3,689 \text{ cm}^4$ $I_y = 2,951 \text{ cm}^4$

S= 2.00 mm 1.778 gr/mt $I_x = 5,062 \text{ cm}^4$ $I_y = 4,110 \text{ cm}^4$



GREENWIN

PVC DOOR AND WINDOWS SYSTEM

GR - 602116

DıŒa Açılır Kanat Profili
Out Turn Sash Profile

створка открытие наружу
بروفیل ضللفة الفته الى الخارج

Ağırlık : 1204 gr/m.

Weight : 1204 gr/m.

Вес : 1204 gr/m.

الوزن : ١٢٠٤ غام

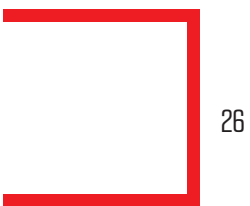
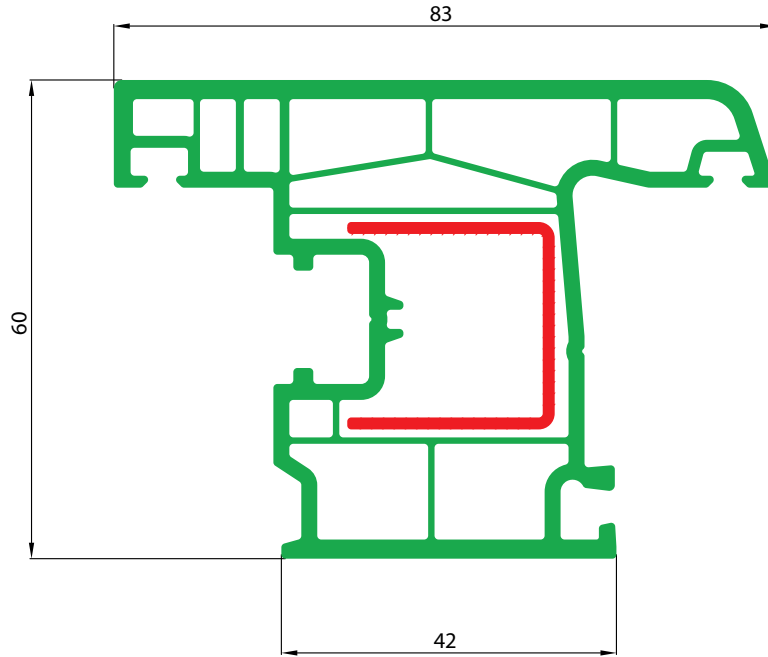
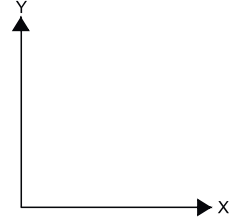

26

S= 1.20 mm 692 gr/mt $I_x= 1,005 \text{ cm}^4$ $I_y= 0,613 \text{ cm}^4$

S= 1.50 mm 866 gr/mt $I_x= 1,295 \text{ cm}^4$ $I_y= 0,780 \text{ cm}^4$

S= 2.00 mm 1.155 gr/mt $I_x= 1,824 \text{ cm}^4$ $I_y= 1,092 \text{ cm}^4$



GREENWIN

PVC DOOR AND WINDOWS SYSTEM

GR 602107

20 mm Çift Cam Çıtası Ağırlık : 178 gr/m.
Double Glazing Bead For 20mm Weight : 178 gr/m.
штапик стеклопакета до 20mm Вес : 178 gr/m.
مثبت الزجاج للزجاج المزدوج ٢٠ ملم الوزن : ١٧٨ غم

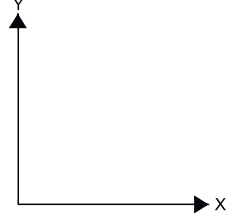
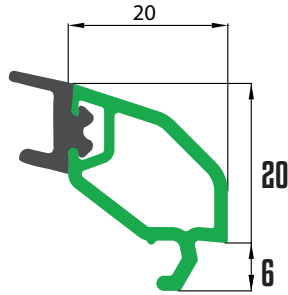

10

GR 602108

Tek Cam Çıtası Profili Ağırlık : 250 gr/m.
Single Glazing Bead Weight : 250 gr/m.
штапик одинарного стекла Вес : 250 gr/m.
مثبت الزجاج للزجاج الواحد الوزن : ٢٥٠ غم

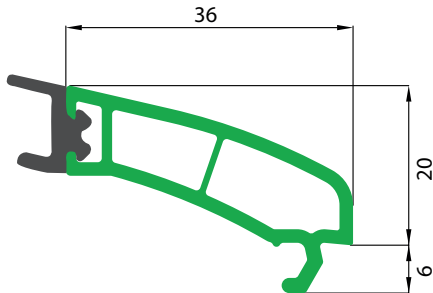

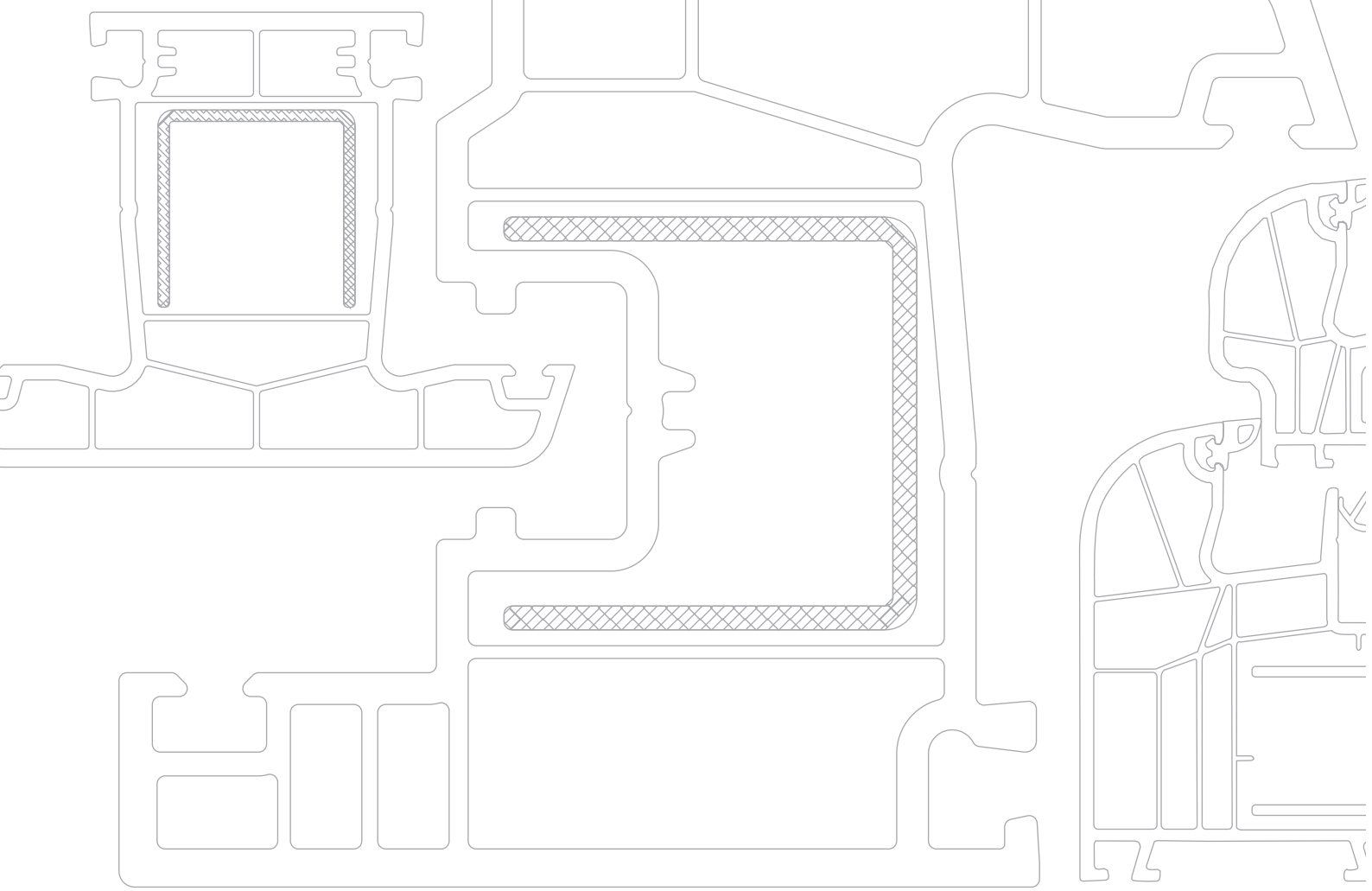

POYRAZ

SERİSİ



GREENWIN

PVC DOOR AND WINDOWS SYSTEM

GR 602101-C

Kasa Profili

Frame

Pama

بروفيل الاطار

Ağırlık : 890 gr/m.

Weight : 890 gr/m.

Bec : 890 gr/m.

الوزن : ٩٢٠ غام

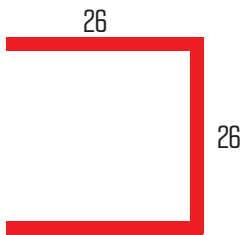
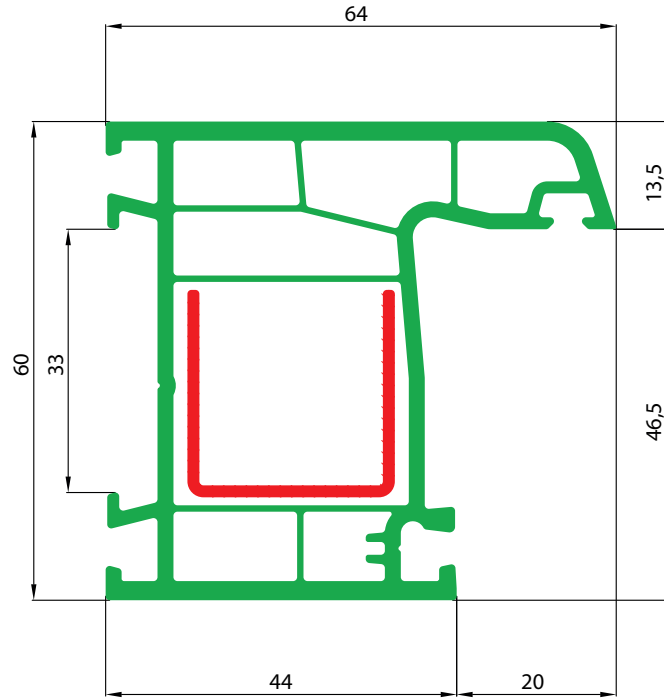
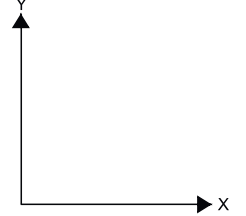

S= 1.20 mm 692 gr/mt $I_x= 1,005 \text{ cm}^4$ $I_y= 0,613 \text{ cm}^4$

S= 1.50 mm 866 gr/mt $I_x= 1,295 \text{ cm}^4$ $I_y= 0,780 \text{ cm}^4$

S= 2.00 mm 1.155 gr/mt $I_x= 1,824 \text{ cm}^4$ $I_y= 1,092 \text{ cm}^4$



GREENWIN

PVC DOOR AND WINDOWS SYSTEM

GR 602102-C

Kanat Profil	Ağırlık	: 1013 gr/m.
Sash	Weight	: 1013 gr/m.
створка	Вес	: 1013 gr/m.
بروفيل الضلعة	الوزن	: ١١٥٠ غم

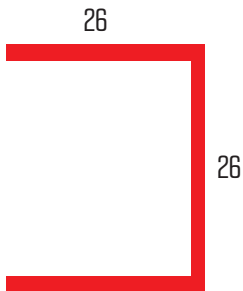
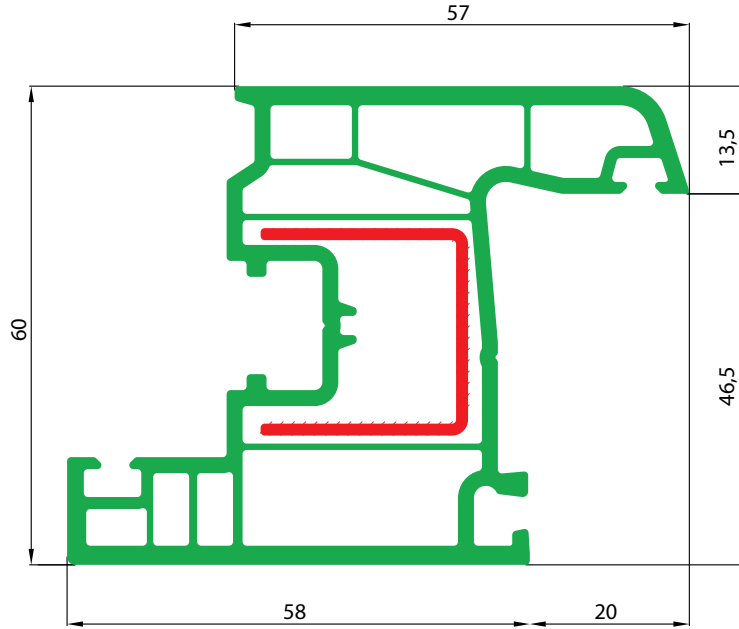
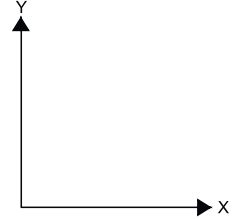

S= 1.20 mm	692 gr/mt	Ix= 1,005 cm ⁴	Iy= 0,613 cm ⁴
S= 1.50 mm	866 gr/mt	Ix= 1,295 cm ⁴	Iy= 0,780 cm ⁴
S= 2.00 mm	1.155 gr/mt	Ix= 1,824 cm ⁴	Iy= 1,092 cm ⁴



GREENWIN

PVC DOOR AND WINDOWS SYSTEM

GR 602103-C

Ortakayıt Profili

Mullion

импост

بروفیل تي

Ağırlık : 1005 gr/m.

Weight : 1005 gr/m.

Вес : 1005 gr/m.

الوزن : ۱۱۱۱ غم

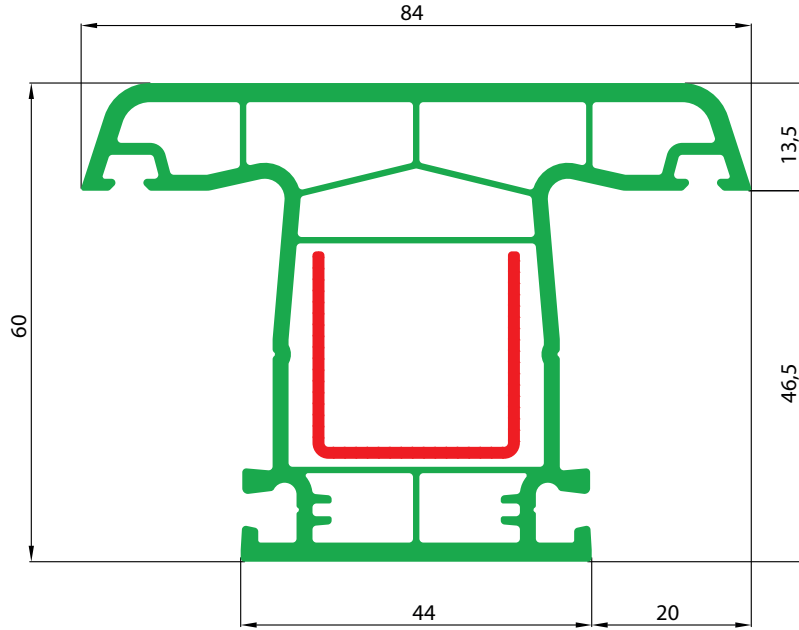
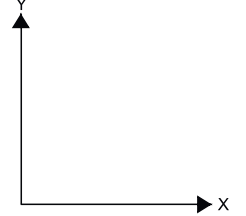

14

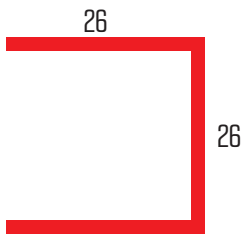

S= 1.20 mm 692 gr/mt $I_x= 1,005 \text{ cm}^4$ $I_y= 0,613 \text{ cm}^4$

S= 1.50 mm 866 gr/mt $I_x= 1,295 \text{ cm}^4$ $I_y= 0,780 \text{ cm}^4$

S= 2.00 mm 1.155 gr/mt $I_x= 1,824 \text{ cm}^4$ $I_y= 1,092 \text{ cm}^4$



GREENWIN

PVC DOOR AND WINDOWS SYSTEM

GR 602105-C

İçe Açılır Kapı Kanat Profili

In turn Door Sash Profile

дверная створка открытие вовнутрь

بروفيل ضلفة الباب الفتحة الى الداخل

Ağırlık : 1234 gr/m.

Weight : 1234 gr/m.

Вес : 1234 gr/m.

الوزن : ١٣٧٨ غم

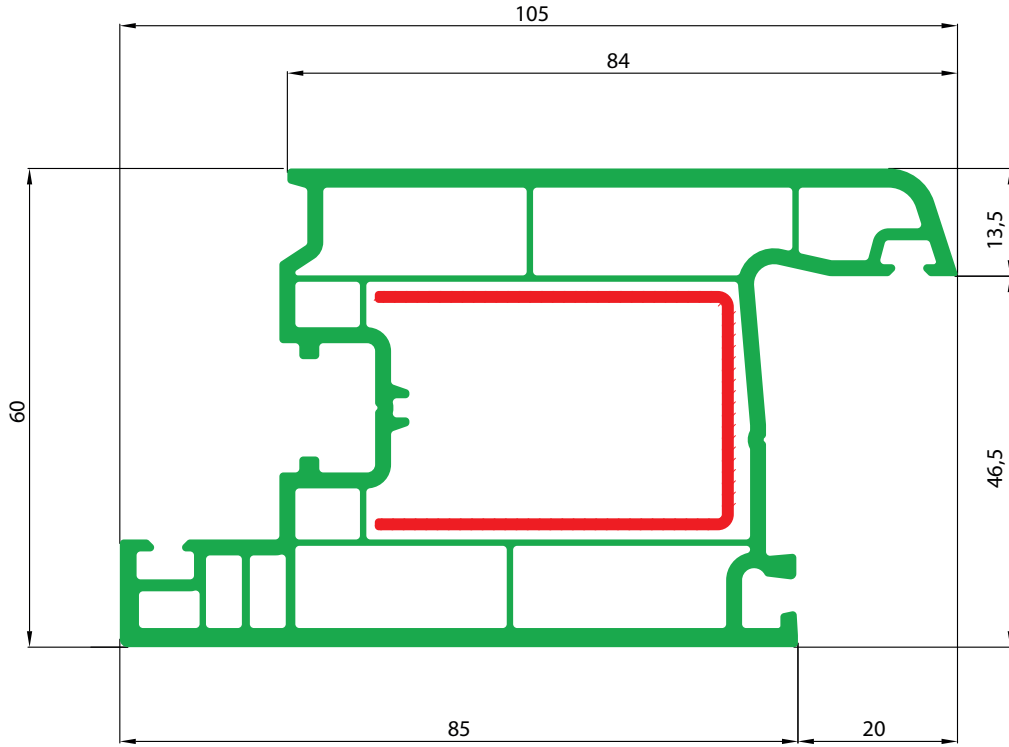
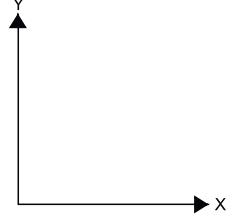

45

30

S= 1.20 mm 1.067 gr/mt lx= 2,919 cm⁴ ly= 2,304 cm⁴

S= 1.50 mm 1.533 gr/mt lx= 3,689 cm⁴ ly= 2,951 cm⁴

S= 2.00 mm 1.778 gr/mt lx= 5,062 cm⁴ ly= 4,110 cm⁴

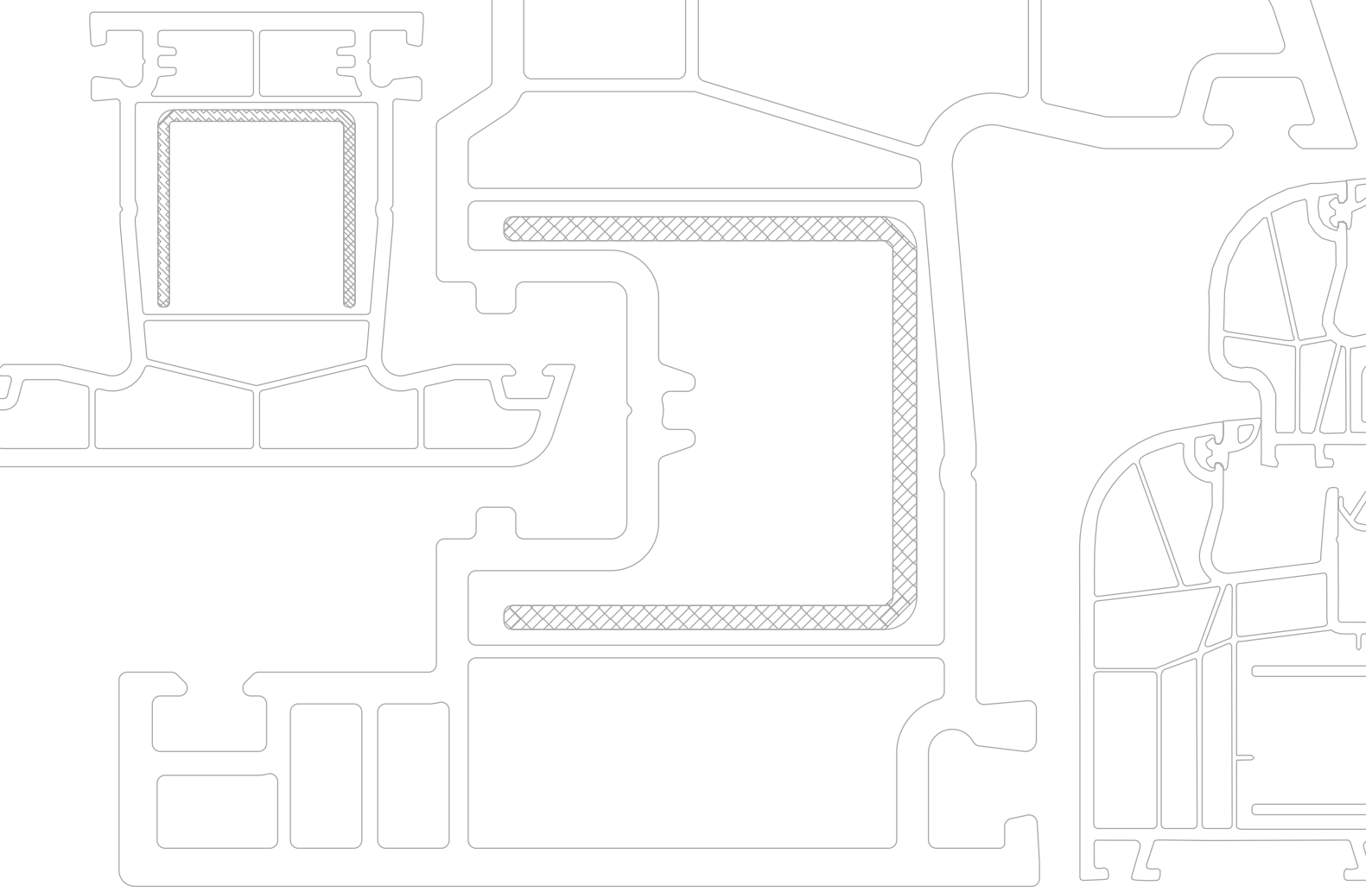

DENİZ

SERİSİ



GREENWIN

PVC DOOR AND WINDOWS SYSTEM

GR 702111

Kasa Profili	Ağırlık	: 1085 gr/m.
Frame	Weight	: 1085 gr/m.
Pama	Bec	: 1085 gr/m.
بروفيل الاطار	الوزن	: ١٠٨٥ غم

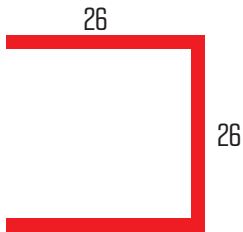
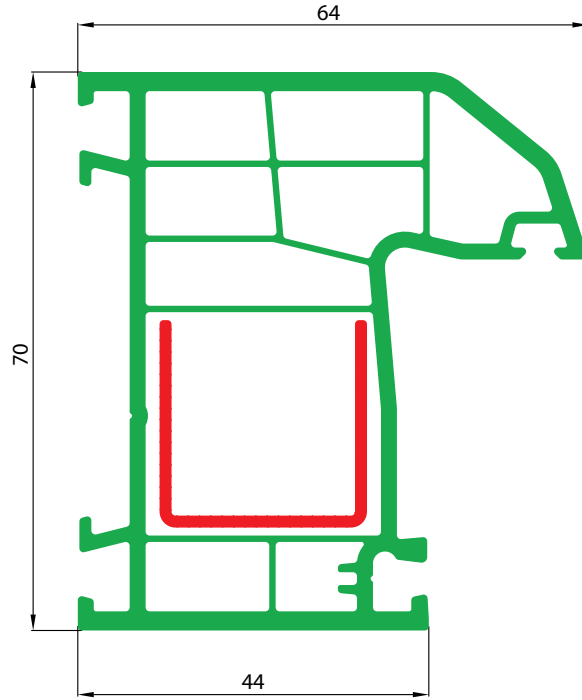
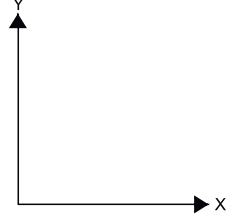

S= 1.20 mm	692 gr/mt	$I_x = 1,005 \text{ cm}^4$	$I_y = 0,613 \text{ cm}^4$
S= 1.50 mm	866 gr/mt	$I_x = 1,295 \text{ cm}^4$	$I_y = 0,780 \text{ cm}^4$
S= 2.00 mm	1.155 gr/mt	$I_x = 1,824 \text{ cm}^4$	$I_y = 1,092 \text{ cm}^4$



GREENWIN

PVC DOOR AND WINDOWS SYSTEM

GR 702112

Kanat Profil : 1200 gr/m.
Sash Weight : 1200 gr/m.
створка Bec : 1200 gr/m.
بروفيل الضلقة الوزن : ١٢٠٠ غام

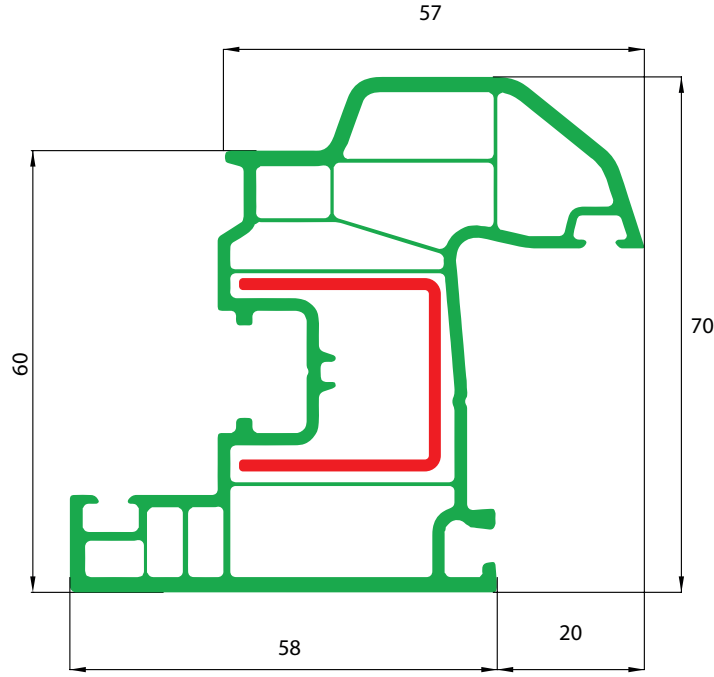
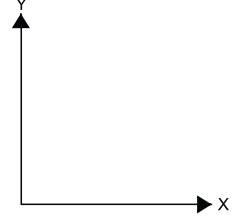

18

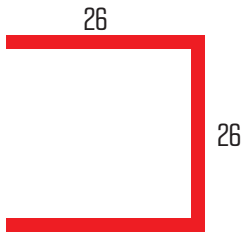

S= 1.20 mm 692 gr/mt $I_x= 1,005 \text{ cm}^4$ $I_y= 0,613 \text{ cm}^4$

S= 1.50 mm 866 gr/mt $I_x= 1,295 \text{ cm}^4$ $I_y= 0,780 \text{ cm}^4$

S= 2.00 mm 1.155 gr/mt $I_x= 1,824 \text{ cm}^4$ $I_y= 1,092 \text{ cm}^4$



GREENWIN

PVC DOOR AND WINDOWS SYSTEM

GR 702113

Ortakayit Profili
Mullion
Импост
بروفيل تي

Ağırlık : 1222 gr/m.
Weight : 1222 gr/m.
Вес : 1222 gr/m.
الوزن : ١٢٢٢ غم

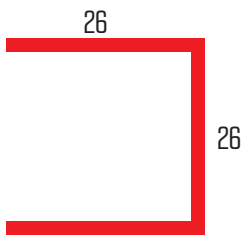
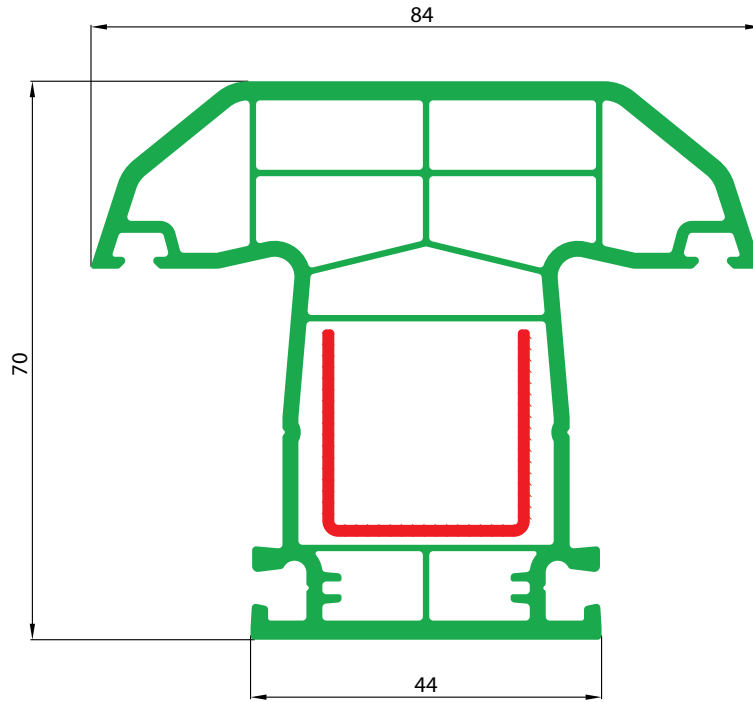
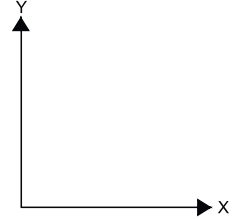

S= 1.20 mm 692 gr/mt $I_x = 1,005 \text{ cm}^4$ $I_y = 0,613 \text{ cm}^4$

S= 1.50 mm 866 gr/mt $I_x = 1,295 \text{ cm}^4$ $I_y = 0,780 \text{ cm}^4$

S= 2.00 mm 1.155 gr/mt $I_x = 1,824 \text{ cm}^4$ $I_y = 1,092 \text{ cm}^4$



GREENWIN

PVC DOOR AND WINDOWS SYSTEM

GR 702114 - Pervazlı Kasa Profili

Pervazlı Kasa Profili
Frame with Cornice Profile
Рама с откосом
بروفیل الإطار بکشف

Ağırlık : 1140 gr/m.
Weight : 1140 gr/m.
Вес : 1140 гр/м
الوزن : 1140 غرام / م.

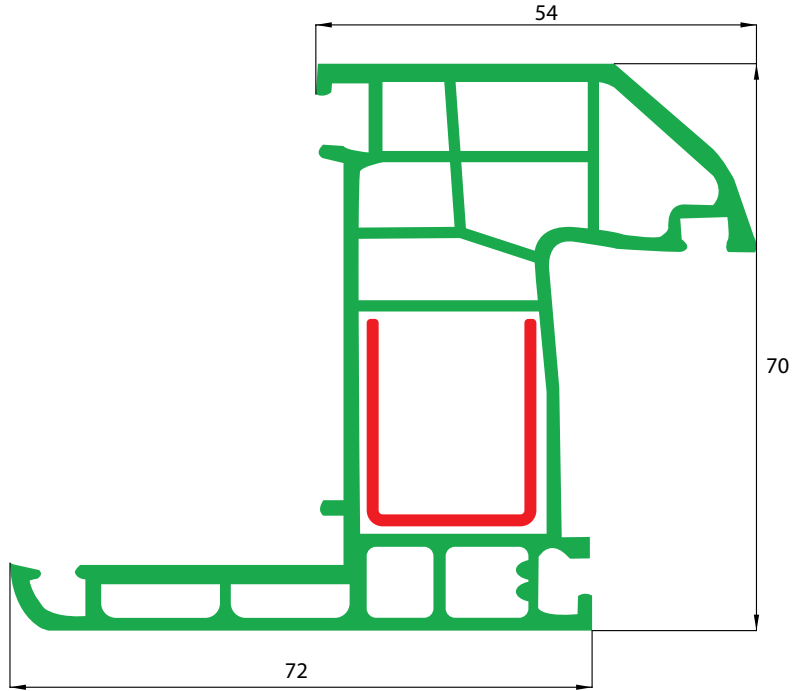
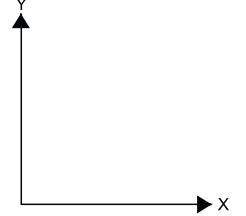

20

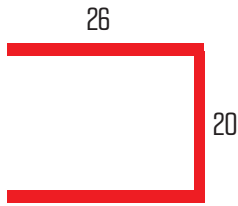

S= 1.20 mm	636 gr/mt	$I_x = 0,549 \text{ cm}^4$	$I_y = 0,556 \text{ cm}^4$
S= 1.50 mm	796 gr/mt	$I_x = 0,713 \text{ cm}^4$	$I_y = 0,707 \text{ cm}^4$
S= 2.00 mm	1.060 gr/mt	$I_x = 1,019 \text{ cm}^4$	$I_y = 0,992 \text{ cm}^4$

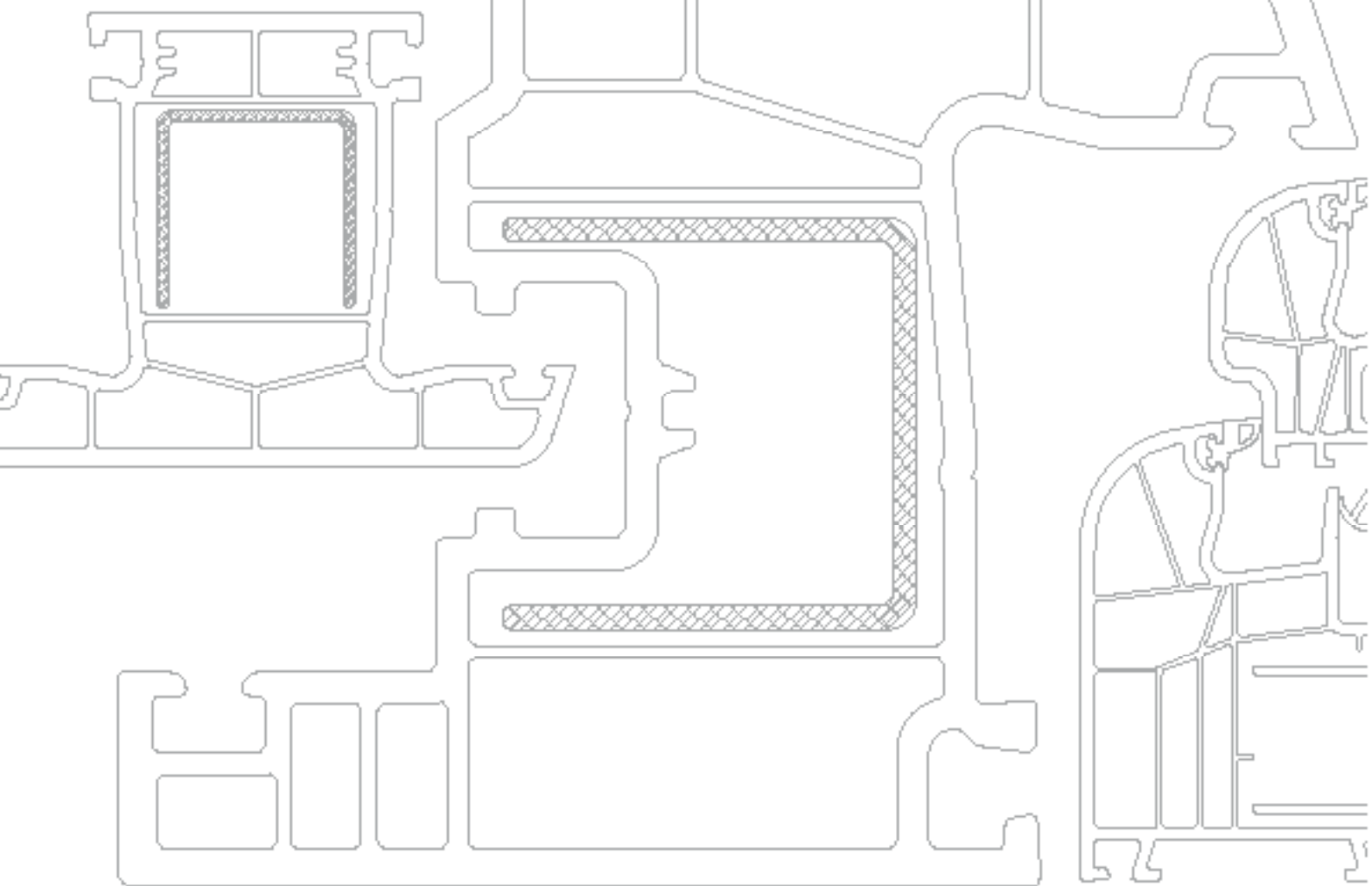

DICLE

SERISI



GREENWIN

PVC DOOR AND WINDOWS SYSTEM

GR 703111 - Kasa Profili 70mm

Kasa Profili
Frame with Cornice Profile
Рама с откосом
بروفيل الإطار بكشف

Ağırlık : 935 gr/m.
Weight : 935 gr/m.
Бec : 935 гр/м
الوزن : 935 غرام / م.

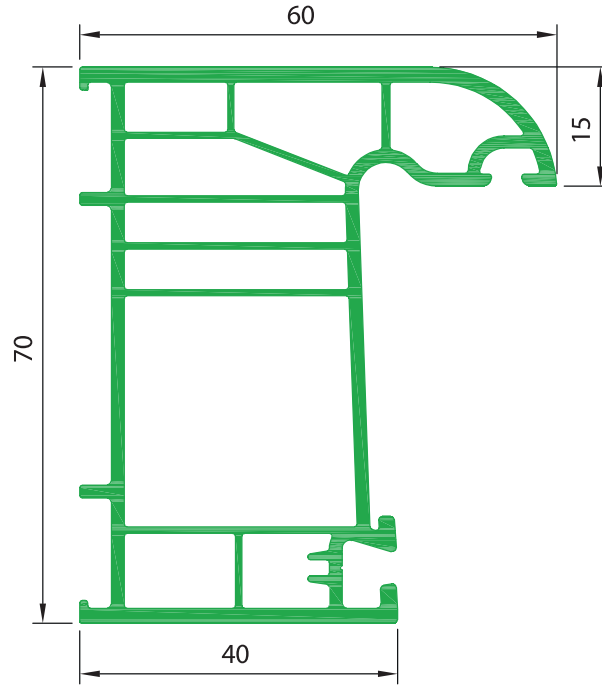
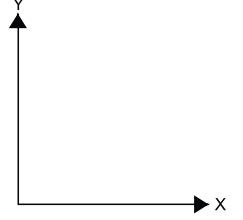



GREENWIN

PVC DOOR AND WINDOWS SYSTEM

GR 703112 - Pencere Kanat Profili 70mm

Kasa Profili
Sash Profile
Рама с откосом
بروفيل الإطار بكشف

Ağırlık : 1120 gr/m.
Weight : 1120 gr/m.
Bec : 1120 гр/м
الوزن : 1120 غرام / م.

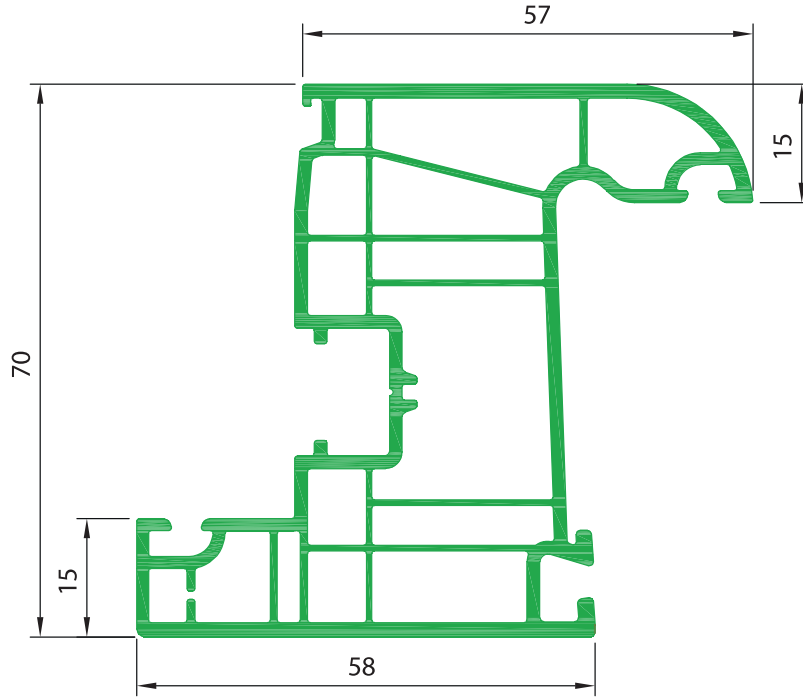
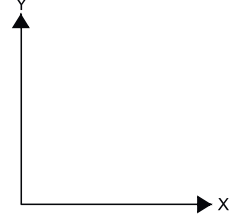



GREENWIN

PVC DOOR AND WINDOWS SYSTEM

GR 703113 - Orta Kayıt Profili 70mm

Kasa Profili
Mullion Profile
Рама с откосом
بروفيل الإطار بكشف

Ağırlık : 1070 gr/m.
Weight : 1070 gr/m.
Вес : 1070 гр/м
الوزن : 1070 غرام / م.

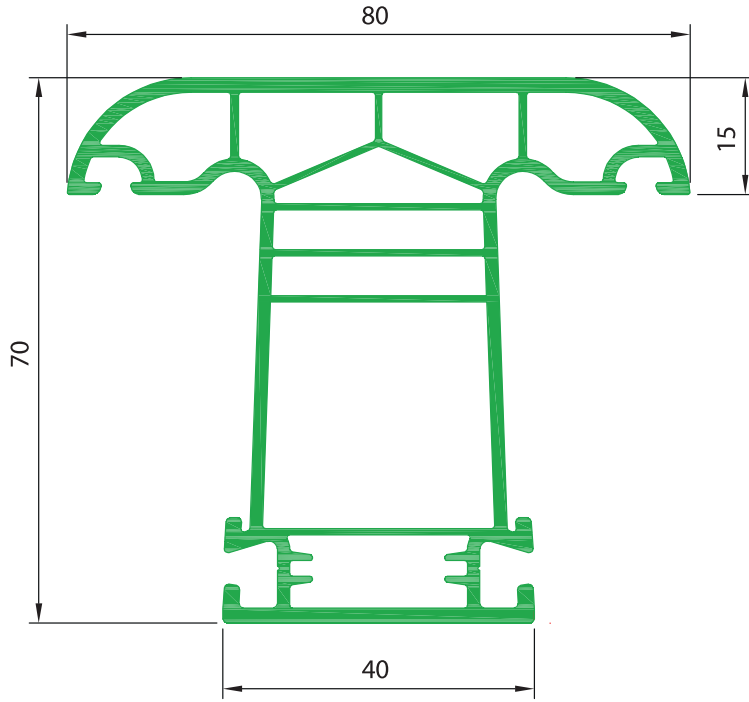
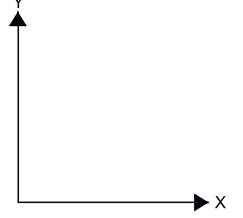



GREENWIN

PVC DOOR AND WINDOWS SYSTEM

GR 703114 - Pervazlı Kasa Profili 70mm

Kasa Profili

Frame with Cornice Profile

Рама с откосом

بروفيل الإطار بكشف

Ağırlık : 1030 gr/m.

Weight : 1030 gr/m.

Вес : 1030 гр/м

الوزن : 1030 غرام / م.

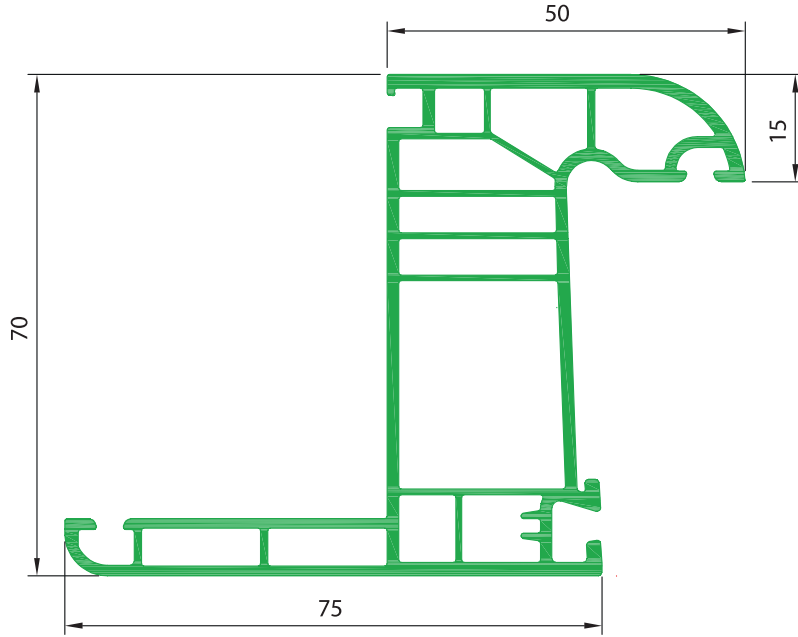
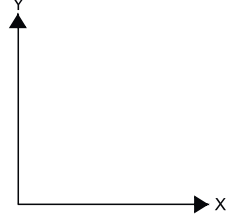



GREENWIN

PVC DOOR AND WINDOWS SYSTEM

GR 703115 - İçe Açılım Kapı Kanat Profili 70mm

Kasa Profili

Door Sash Profile

Рама с откосом

بروفيل الإطار بكشف

Ağırlık : 1430 gr/m.

Weight : 1430 gr/m.

Вес : 1430 гр/м

الوزن : 1430 غرام / م.

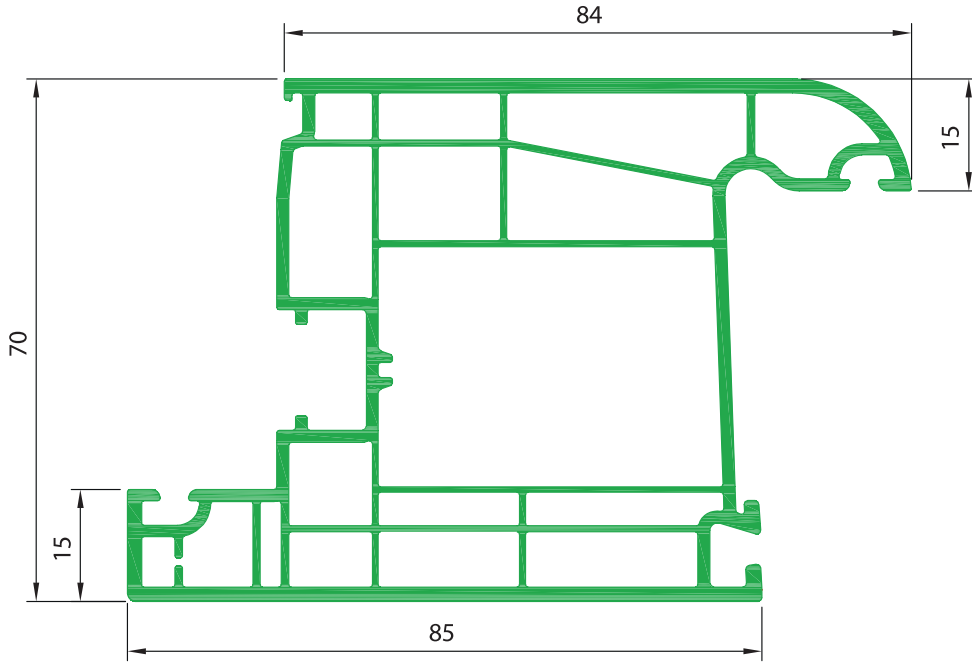
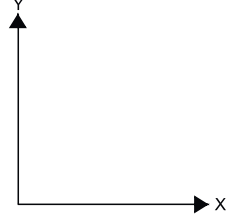



GREENWIN

PVC DOOR AND WINDOWS SYSTEM

GR 703116 - Çift Cam Çitası 20mm

Kasa Profili

Frame with Cornice Profile

Рама с откосом

بروفيل الإطار بكشف

Ağırlık : 260 gr/m.

Weight : 260 gr/m.

Bec : 260 гр/м

الوزن : 260 غرام / م.

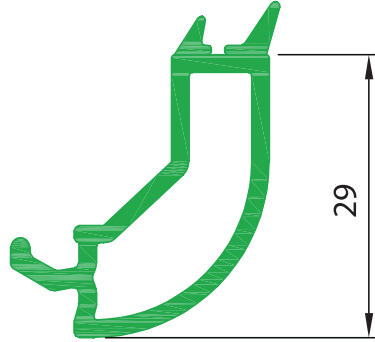
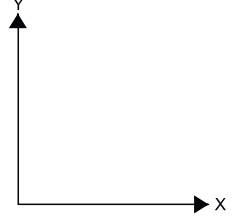

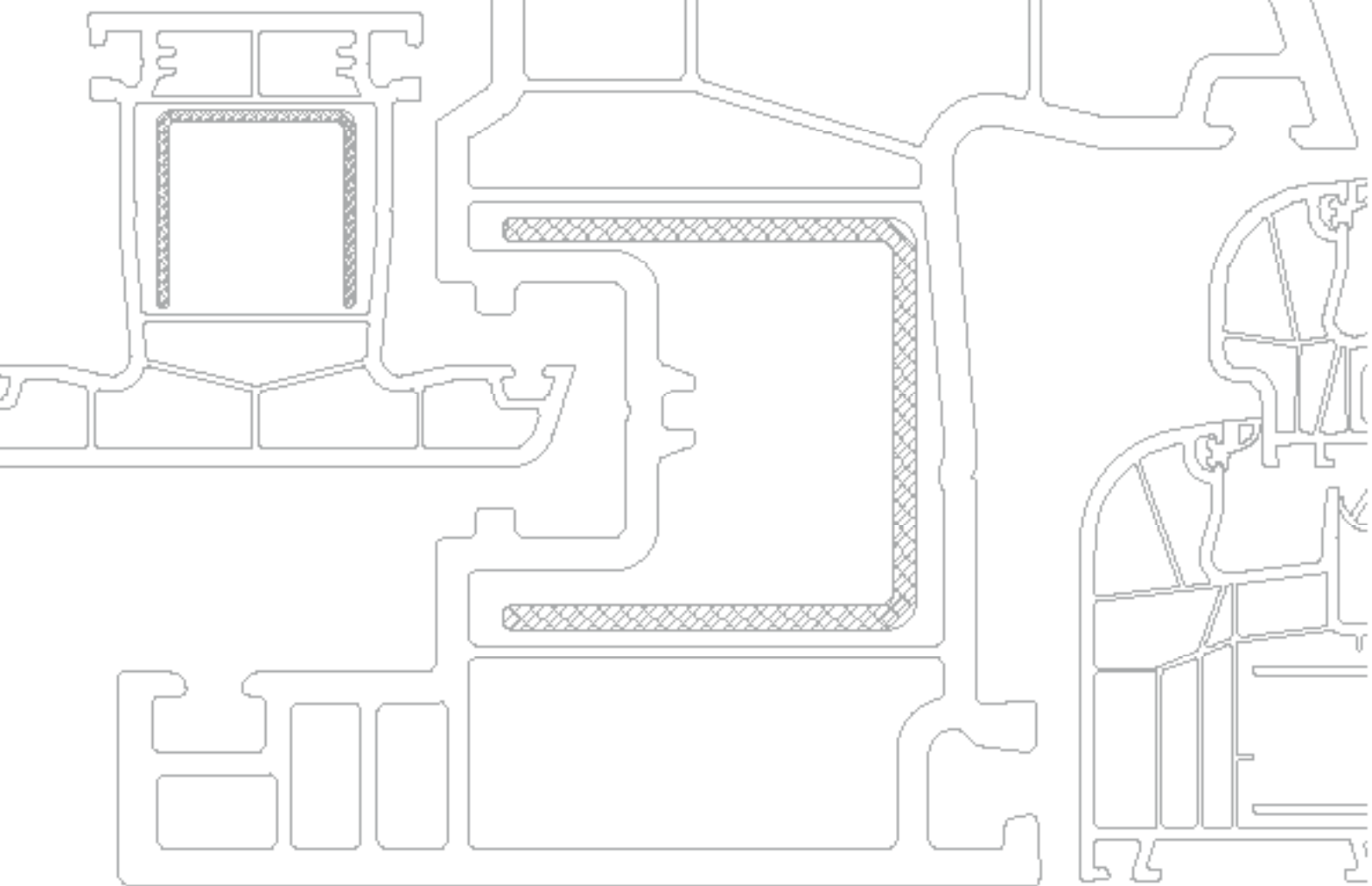

DICLE A⁺

SERISI



GREENWIN

PVC DOOR AND WINDOWS SYSTEM

GR 701112 - Pencere Kanat Profili 70mm

Kasa Profili

Sash Profile

Рама с откосом

بروفيل الإطار بكشف

Ağırlık : 1480 gr/m.

Weight : 1480 gr/m.

Вес : 1480 гр/м

الوزن : 1480 غرام / م.

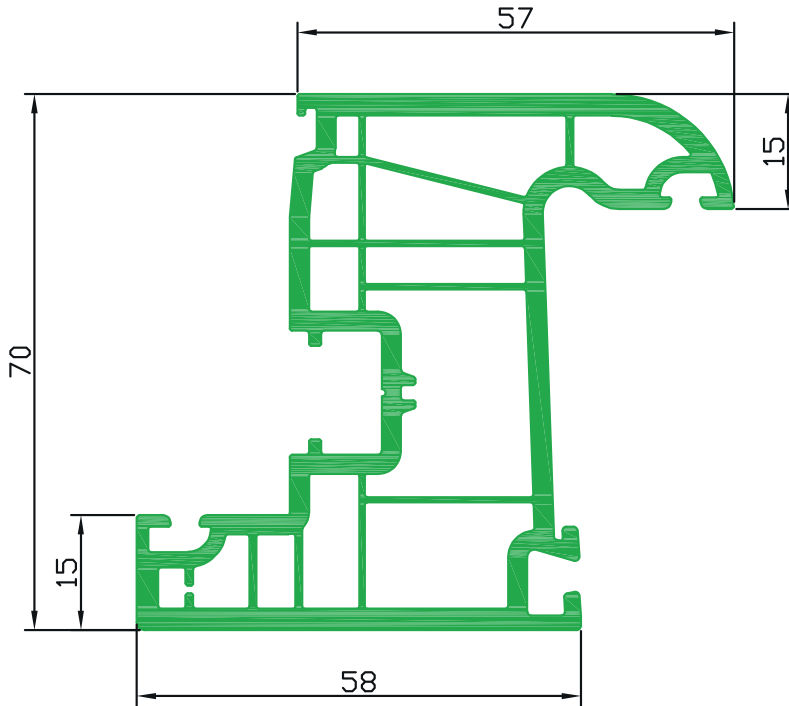
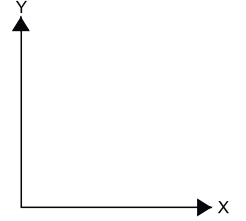



GREENWIN

PVC DOOR AND WINDOWS SYSTEM

GR 701113 - Orta Kayıt Profili 70mm

Kasa Profili
Mullion Profile
Рама с откосом
بروفيل الإطار بكشف

Ağırlık : 1390 gr/m.
Weight : 1390 gr/m.
Вес : 1390 гр/м
الوزن : 1390 غرام / م.

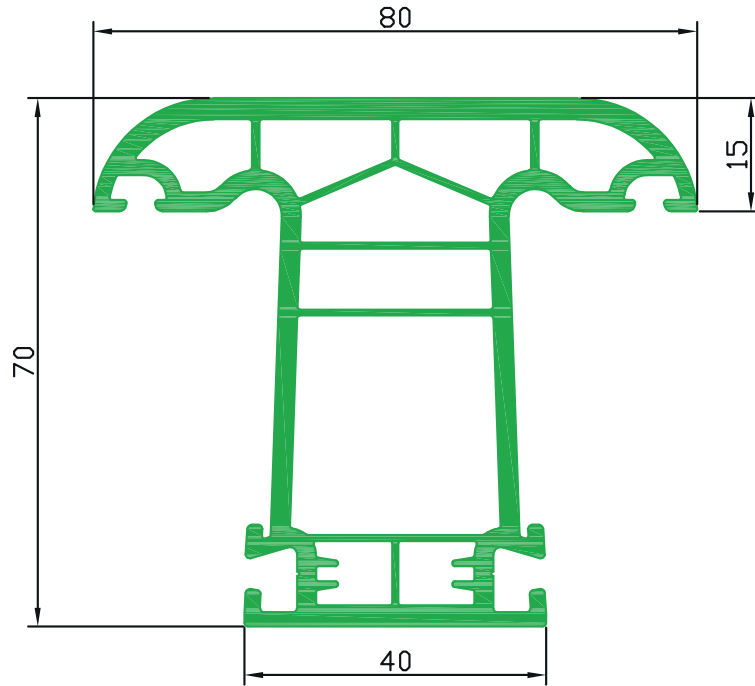
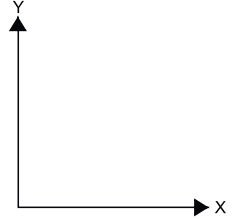

30



GREENWIN

PVC DOOR AND WINDOWS SYSTEM

GR 701114 - Pervazlı Kasa Profili 70mm

Kasa Profili

Frame with Cornice Profile

Рама с откосом

بروفيل الإطار بكشف

Ağırlık : 1340 gr/m.

Weight : 1340 gr/m.

Вес : 1340 гр/м

الوزن : 1340 غرام / م.

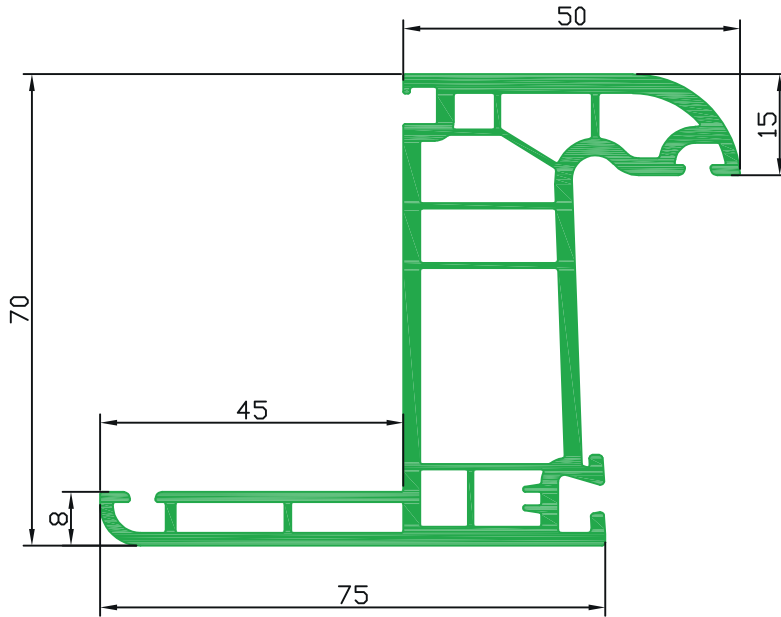
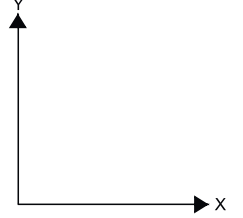



GREENWIN

PVC DOOR AND WINDOWS SYSTEM

GR 701115 - İçe Açılım Kapı Kanat Profili 70mm

Kasa Profili

Door Sash Profile

Рама с откосом

بروفيل الإطار بكشيف

Ağırlık : 1850 gr/m.

Weight : 1850 gr/m.

Вес : 1850 гр/м

الوزن : 1430 غرام / م.

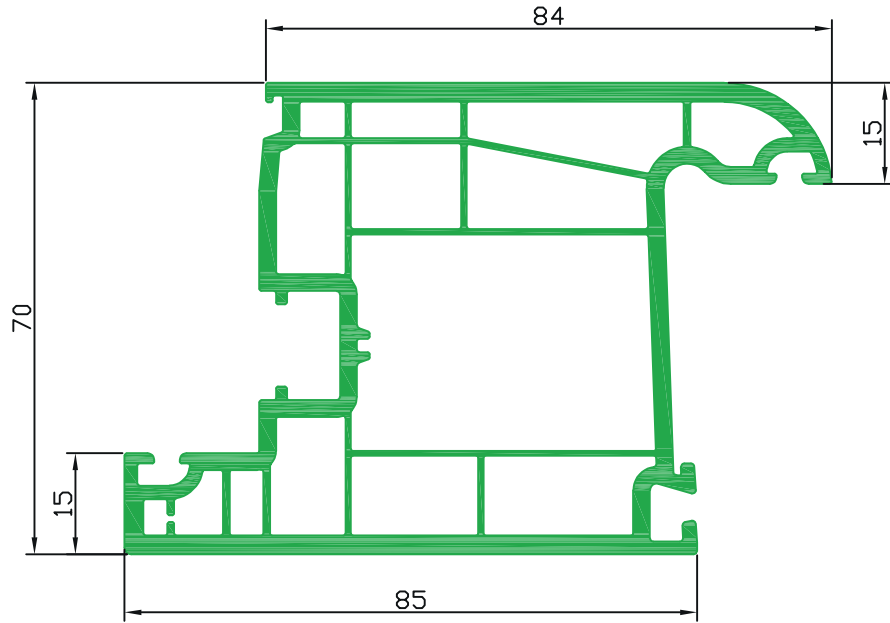
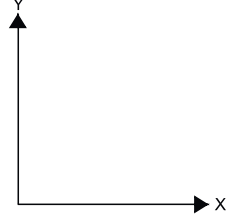

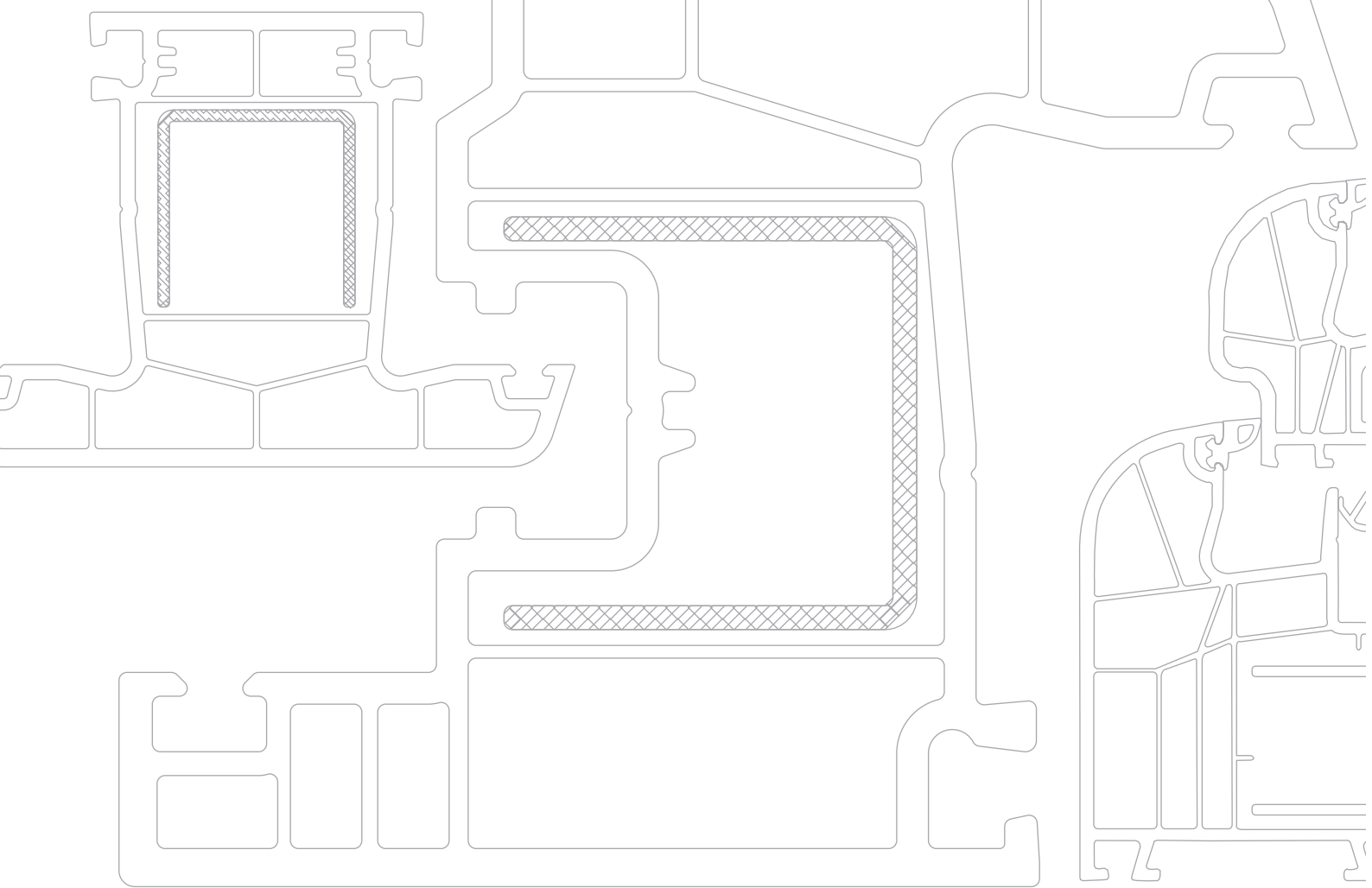

OKYANUS

SERISI



GREENWIN

PVC DOOR AND WINDOWS SYSTEM

GR 802101

Kasa Profili

Frame

Pama

بروفيل الاطار

Ağırlık : 1546gr/m

Weight : 1546gr/m

Bec : 1546gr/m

الوزن : ١٥٤٦ غم

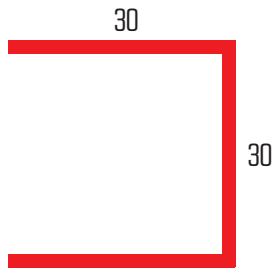
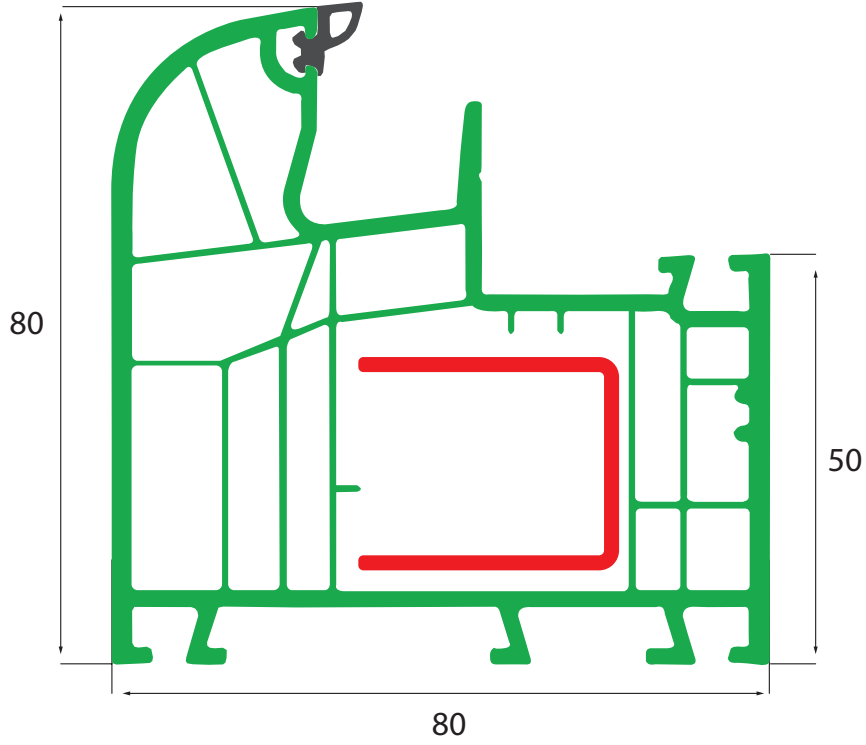
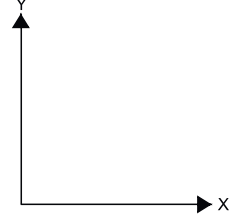

S= 1.20 mm 805 gr/mt $I_x= 1,663 \text{ cm}^4$ $I_y= 0,988 \text{ cm}^4$

S= 1.50 mm 1.006 gr/mt $I_x= 2,030 \text{ cm}^4$ $I_y= 1,218 \text{ cm}^4$

S= 2.00 mm 1.341 gr/mt $I_x= 2,586 \text{ cm}^4$ $I_y= 1,576 \text{ cm}^4$



GREENWIN

PVC DOOR AND WINDOWS SYSTEM

GR812102

Damlıklı Kanat Profil Ağırlık : 1398gr/m
Sash Weight :1398 gr/m
СТВОРКА Bec : B98 gr/m
الوزن بروفيل الضلفة ١٣٩٨ غم

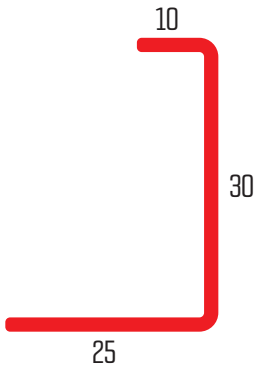
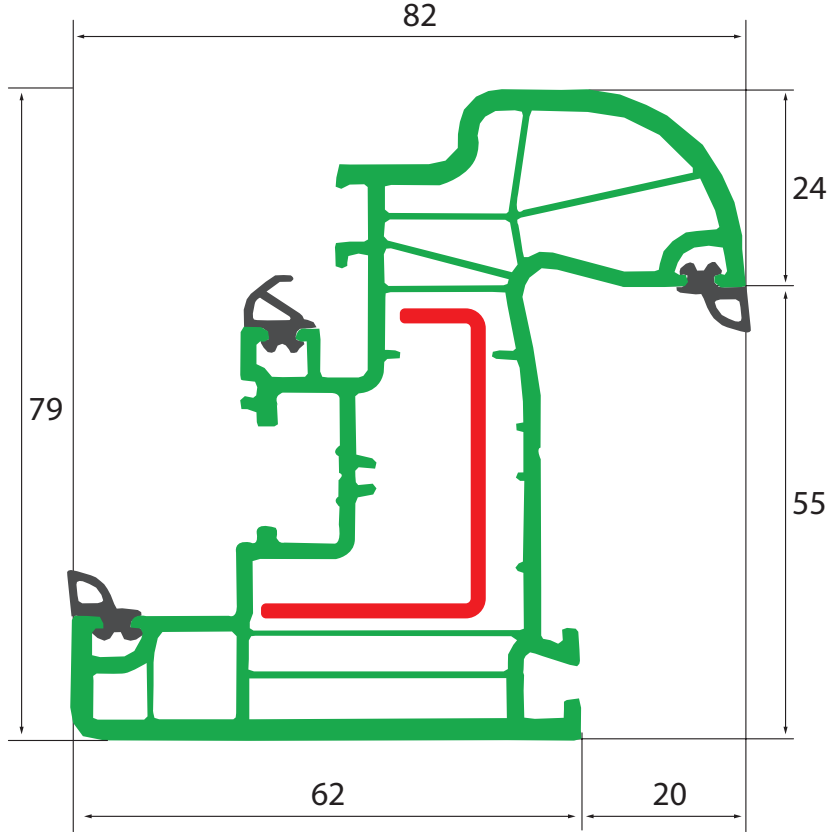
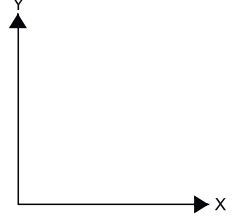

S= 1.20 mm	571 gr/mt	$I_x = 1,113 \text{ cm}^4$	$I_y = 0,270 \text{ cm}^4$
S= 1.50 mm	713 gr/mt	$I_x = 1,353 \text{ cm}^4$	$I_y = 0,328 \text{ cm}^4$
S= 2.00 mm	952 gr/mt	$I_x = 1,721 \text{ cm}^4$	$I_y = 0,421 \text{ cm}^4$

35



GREENWIN

PVC DOOR AND WINDOWS SYSTEM

GR 812103

Ortakayıt Profili
Mullion

ИМПОРТ

بروفیل تی

Ağırlık : 1780 gr/m

Weight: 1780 gr/m

Bec: 1780 gr/m

الوزن ۱۷۸۰ غم

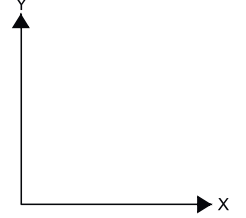

36

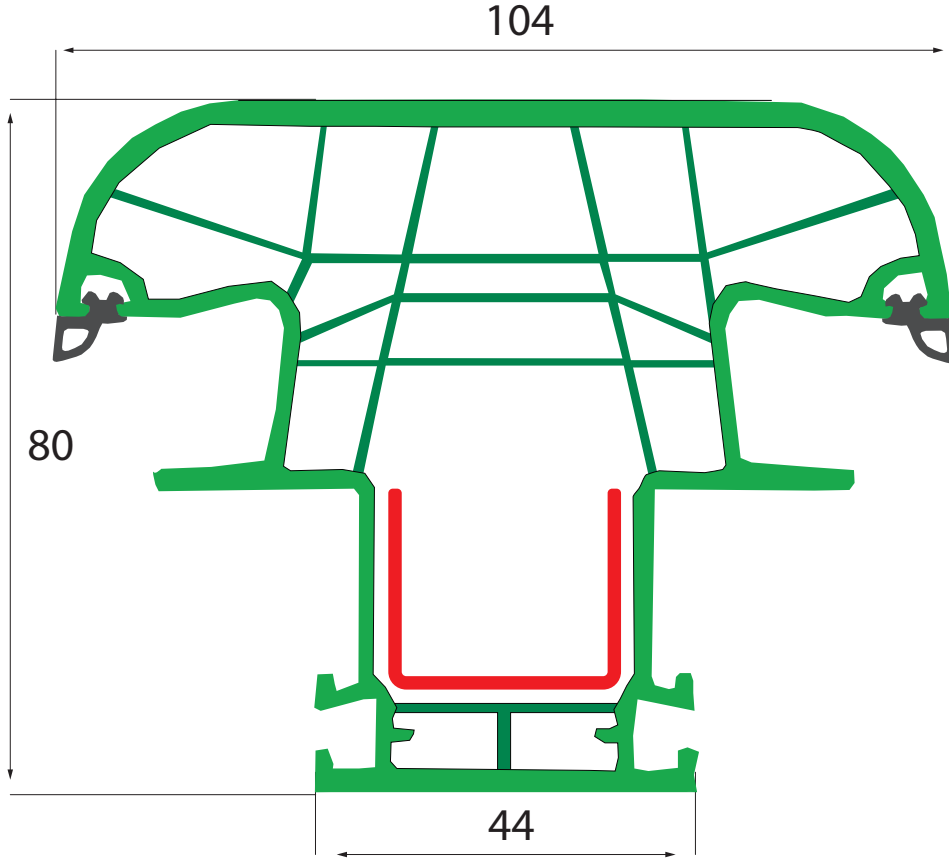

25

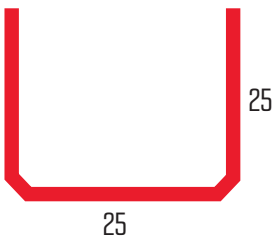

S= 1.20 mm 664 gr/mt $I_x= 0,965 \text{ cm}^4$ $I_y= 0,577 \text{ cm}^4$

S= 1.50 mm 830 gr/mt $I_x= 1,169 \text{ cm}^4$ $I_y= 0,707 \text{ cm}^4$

S= 2.00 mm 1.108 gr/mt $I_x= 1,480 \text{ cm}^4$ $I_y= 0,913 \text{ cm}^4$



GREENWIN

PVC DOOR AND WINDOWS SYSTEM

GR802104

içe Açılır Kapı Kanat Profili
In turn Door Sash Profile

дверная створка открытие вовнутрь
بروفيل ضلفة الباب الفتحة الى الداخل

Ağırlık : 1940 gr/m

Weight 1940 gr/m

Вес : 1940 gr/m

الوزن ١٩٤٠ غم

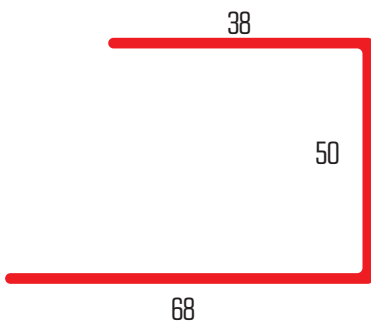
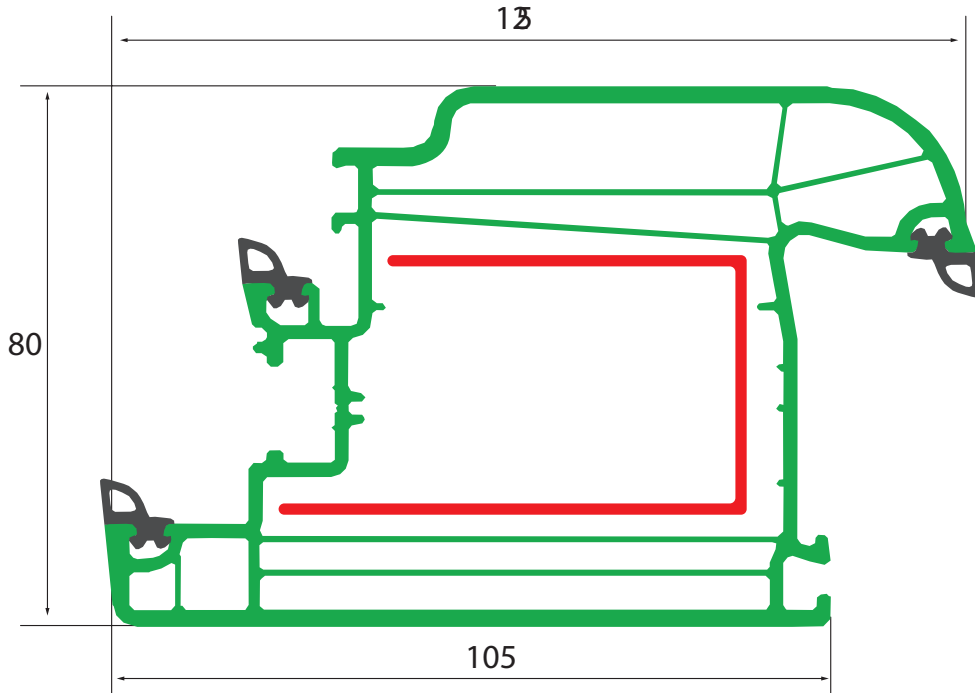
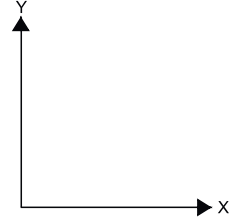

S= 1.20 mm 1,423 gr/mt $I_x= 8,207 \text{ cm}^4$ $I_y= 4,501 \text{ cm}^4$

S= 1.50 mm 1,778 gr/mt $I_x= 10,154 \text{ cm}^4$ $I_y= 5,526 \text{ cm}^4$

S= 2.00 mm 2,371 gr/mt $I_x= 13,310 \text{ cm}^4$ $I_y= 7,150 \text{ cm}^4$



PVC DOOR AND WINDOWS SYSTEM

GR812105

24 mm Çift Cam Çıtası Ağırlık : 217 gr/m

Double Glazing Bead For 24mm Weight 217 gr/m

штапик стеклопакета до 24mm Bec : 217 gr/m

مثبت الزجاج للزجاج المزدوج ٢٠ملم الوزن غام ٢١٧

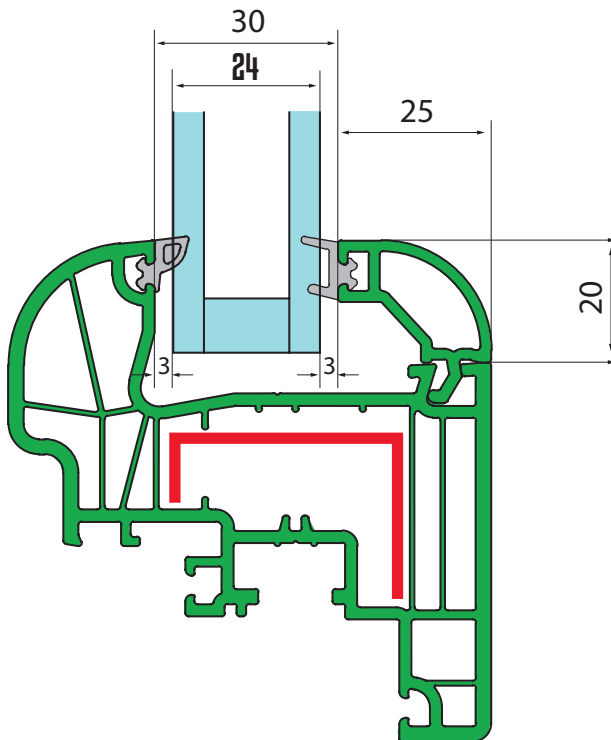
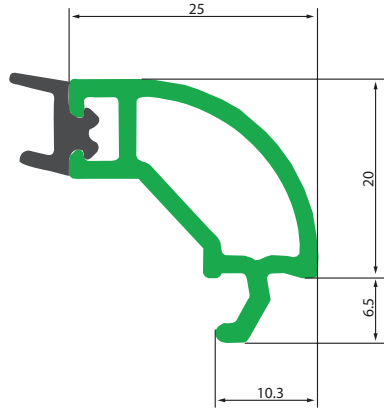
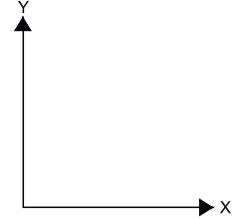

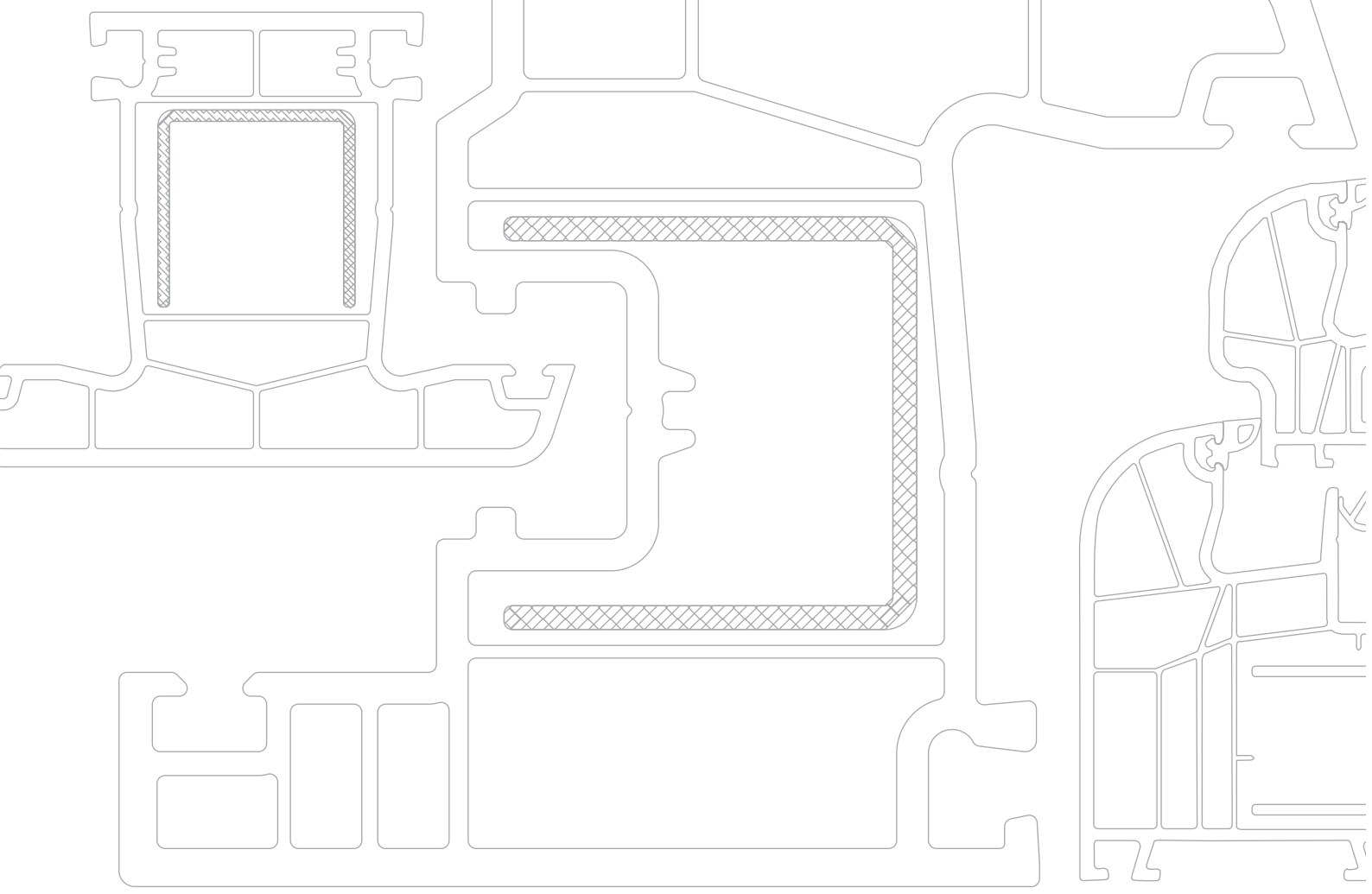

YARDIMCI

PROFIL



GREENWIN

PVC DOOR AND WINDOWS SYSTEM

Kutu Profili Ağırılık : 900 gr/m.
Box Profile Weight : //
Профиль коробка Вес : 900 гр/м
بروفيل العلبه الوزن : ٩٠٠ غ / م

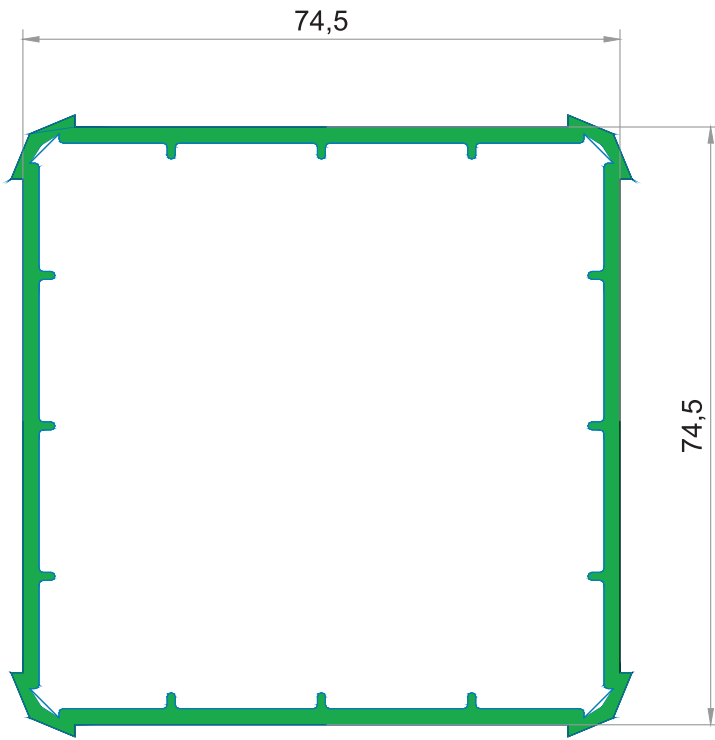

Köşe Dönüş Adaptör Profili
Corner Adaptor
Адаптор
بروفيل أدبتر المعدل للزاوية

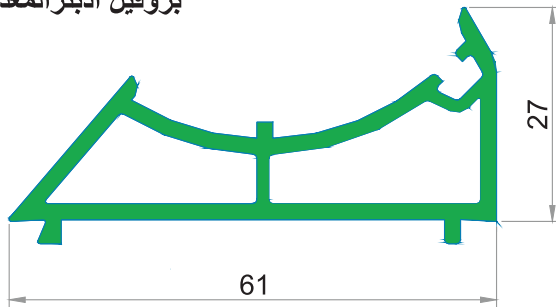



GREENWIN

PVC DOOR AND WINDOWS SYSTEM

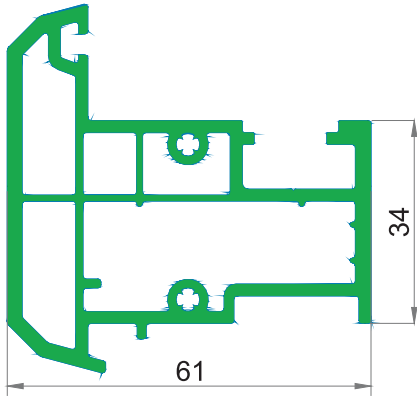

Hareketli Ortakayıt Profili
False Mullion Profile
Штульповый профиль
بروفيل تي المتحركة

Ağırlık : 1010 gr/m.
Weight : //
Вес : 1010 гр/м
الوزن : ١٠١٠ غ / م

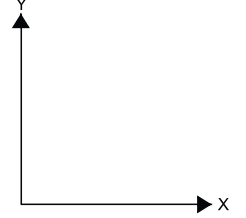

Boru Profili
Pipe Profile
Трубный профиль
بروفيل أنبوب

Ağırlık : 520 gr/m.
Weight : //
Вес : 520 гр/м
الوزن : ٥٢٠ غ / م

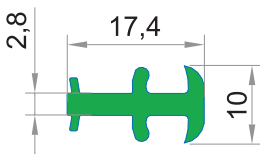
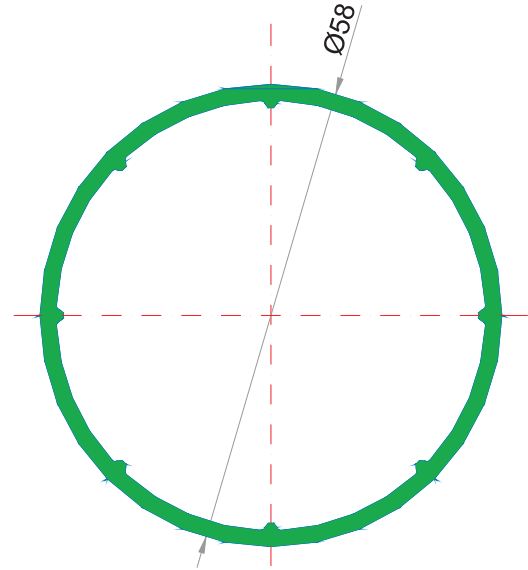

Üniversal Bağ Profili
Universal Connecting Profile
Универсальный
соединительный профиль
بروفيل الربط أوني وارسال



GREENWIN

PVC DOOR AND WINDOWS SYSTEM

Pervaz Profili (60x90) (6,5x10,5)
Cornice Profile (60x90) (6,5x10,5)
Профиль откоса (60x90) (6,5x10,5)
بروفیل کشف (۶۰x۹۰)

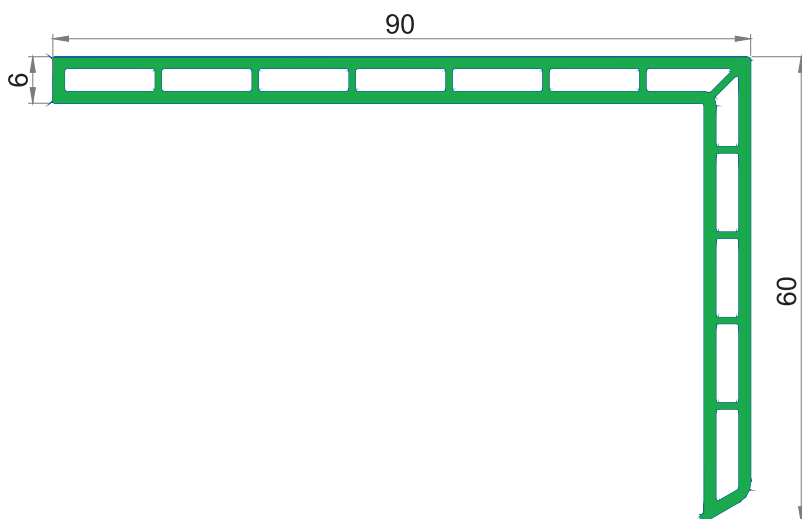
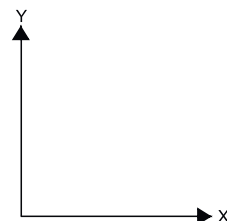

Lambiri (Panel) profili
Panel profile
Füll - (Panel) profil
Панель профиль
بروفیل کشف

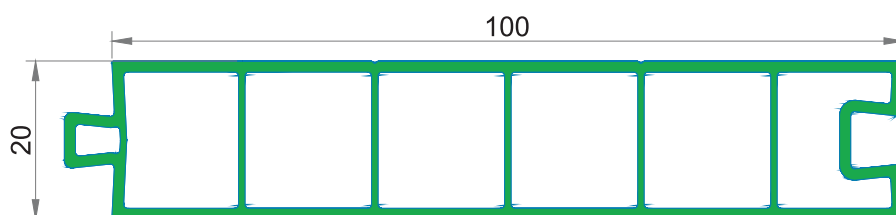



Kasa - Kanat Uygulaması
Frame - Sash, cross - section
Применение рама-створка
تطبيق اللإطار مع الضلفة

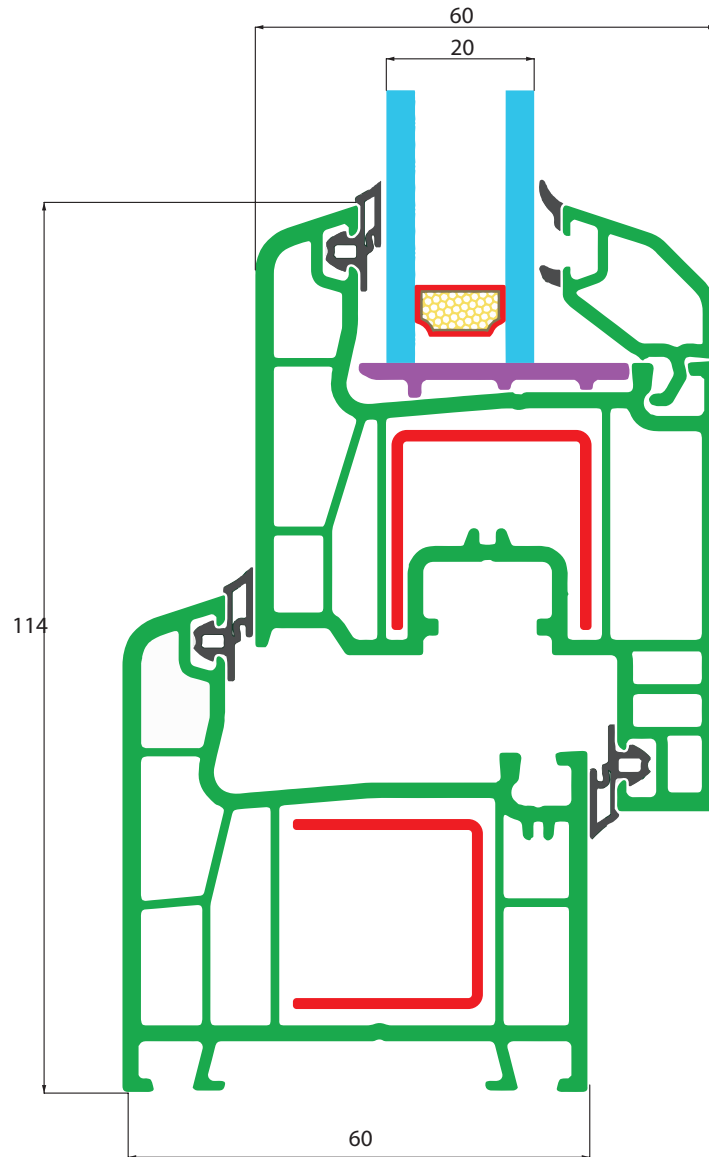
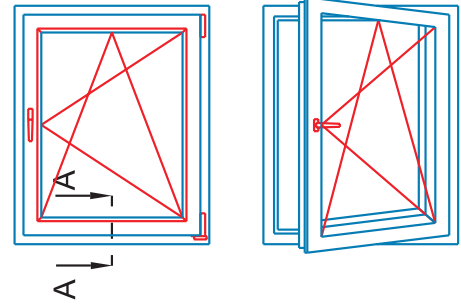



GREENWIN

PVC DOOR AND WINDOWS SYSTEM

Kasa - İçe Açılım Kapı Kanadı Uygulaması

Frame In turn Door Sash, cross-section

Применение Рама-Дверная Створка Открытие Вовнутрь

تطبيق الإطار مع ضلفة الباب الفتح إلى الداخل

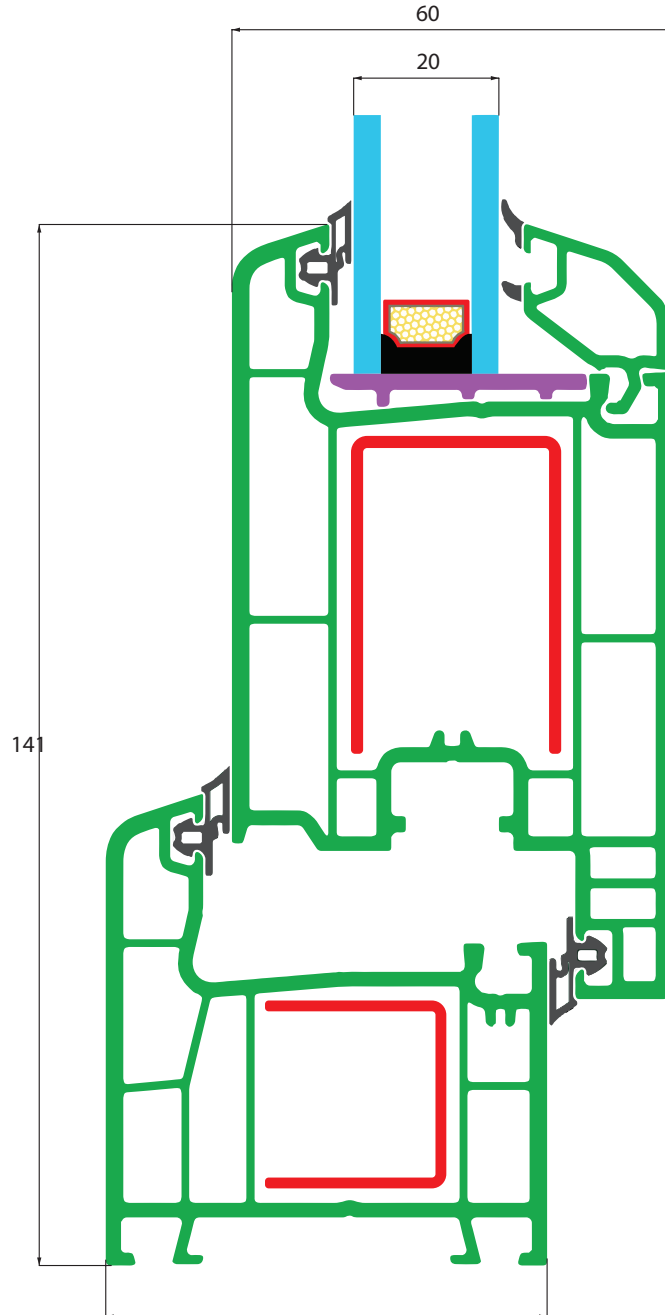
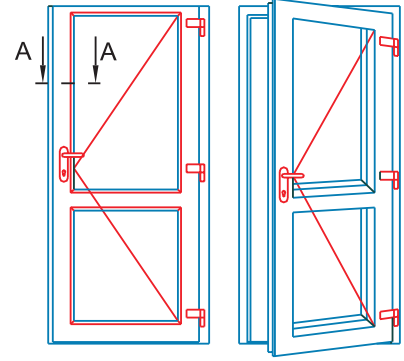



Kasa - Dışa Açılım Kapı Kanadı Uygulaması
Frame - Out turn Door Sash, cross - section
Применение рама- дверная створка открытие Наружу
تطبيق الإطار مع ضلفة الباب الفتح إلى الخارج

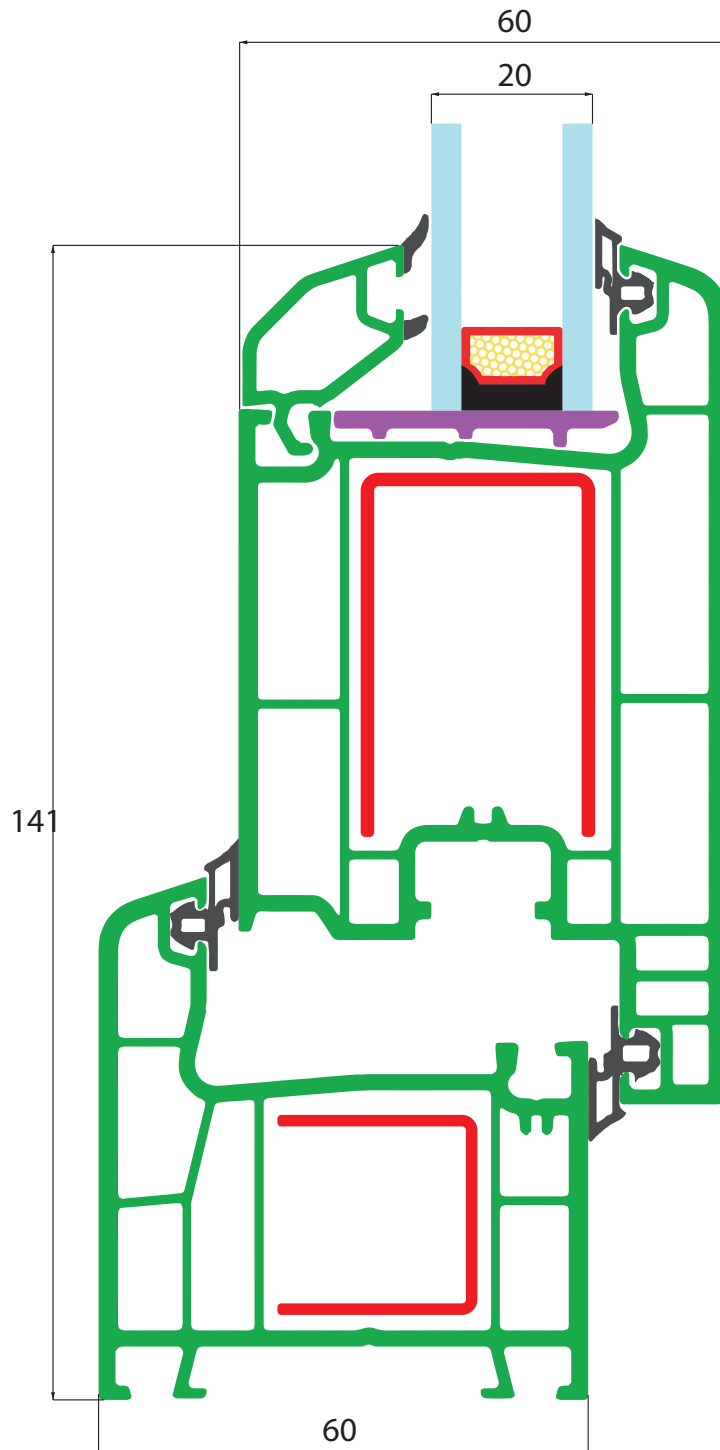
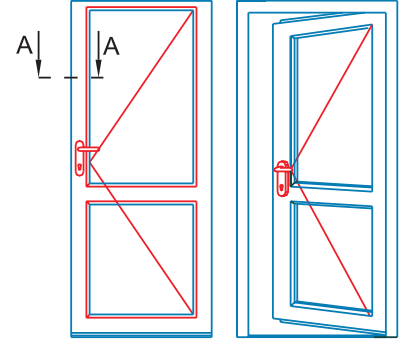



Pervazlı Kasa - Kanat Uygulaması
Frame with Cornice Sash, cross-section
Применение рама створка с откосом
تطبيق الإطار بكشف مع الضلعة

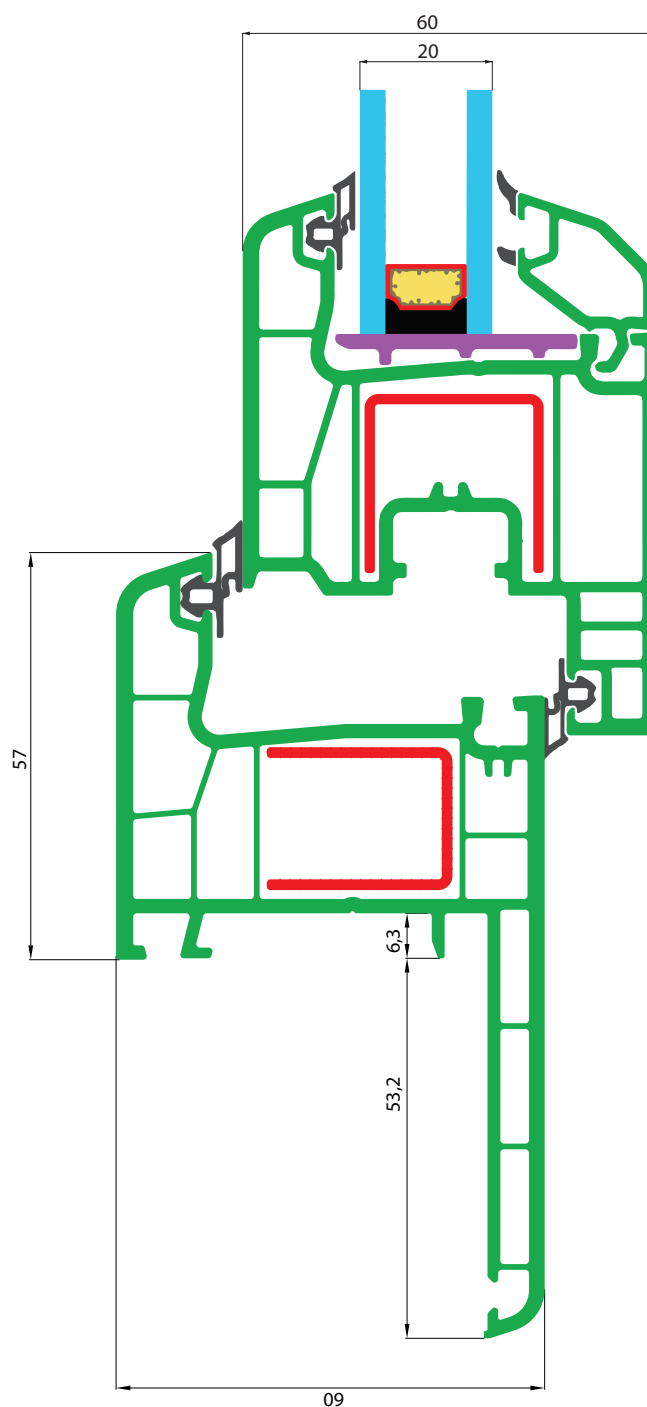
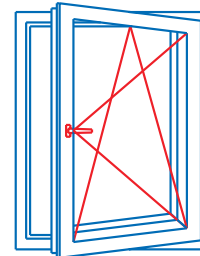
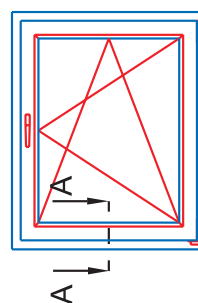



Pervazlı Kasa - Kanat Uygulaması
Frame with Cornice Sash, cross-section
Применение рама створка с откосом
تطبيق الإطار بكشف مع الضلعة

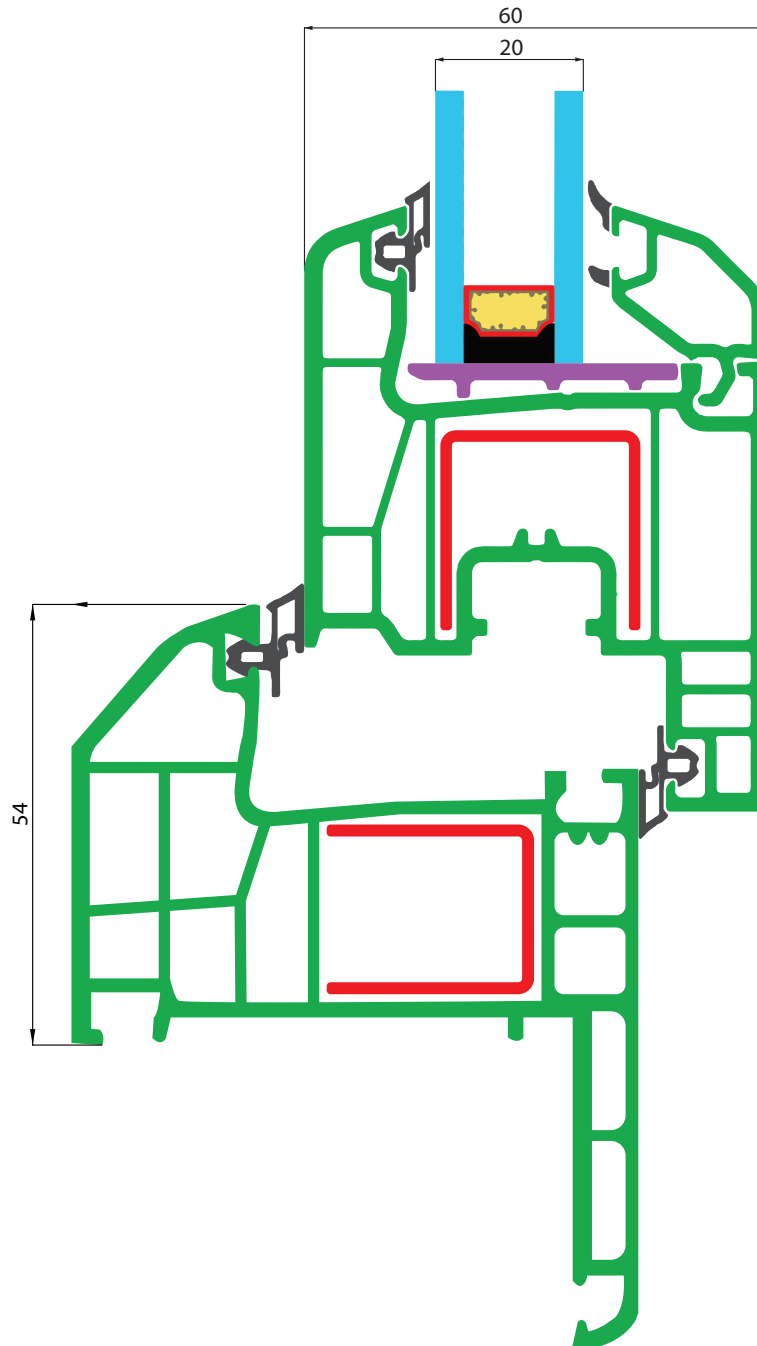
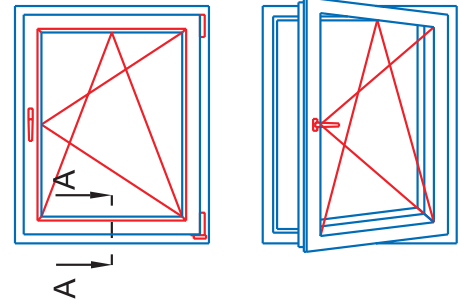



Kasa - Kanat Uygulaması
Frame - Sash, cross - section
Применение рама-створка
تطبيق الإطار مع الضلفة

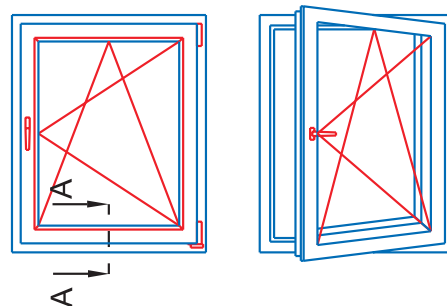

48

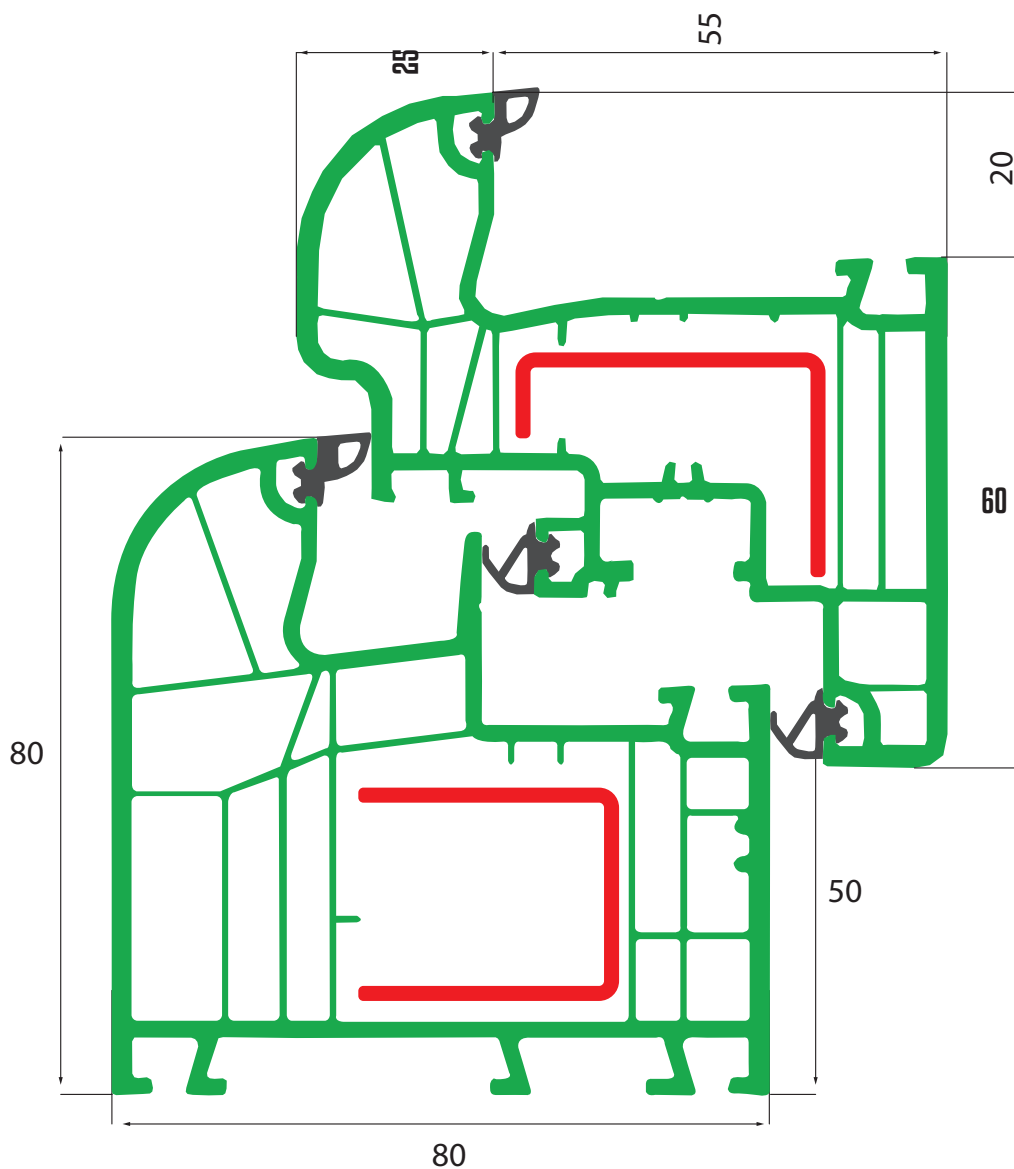



Kasa - İçe Açılım Kapı Kanadı Uygulaması

Frame In turn Door Sash, cross-section

Применение Рама-Дверная Створка Открытие Вовнутрь

تطبيق الإطار مع ضلفة الباب الفتح إلى الداخل

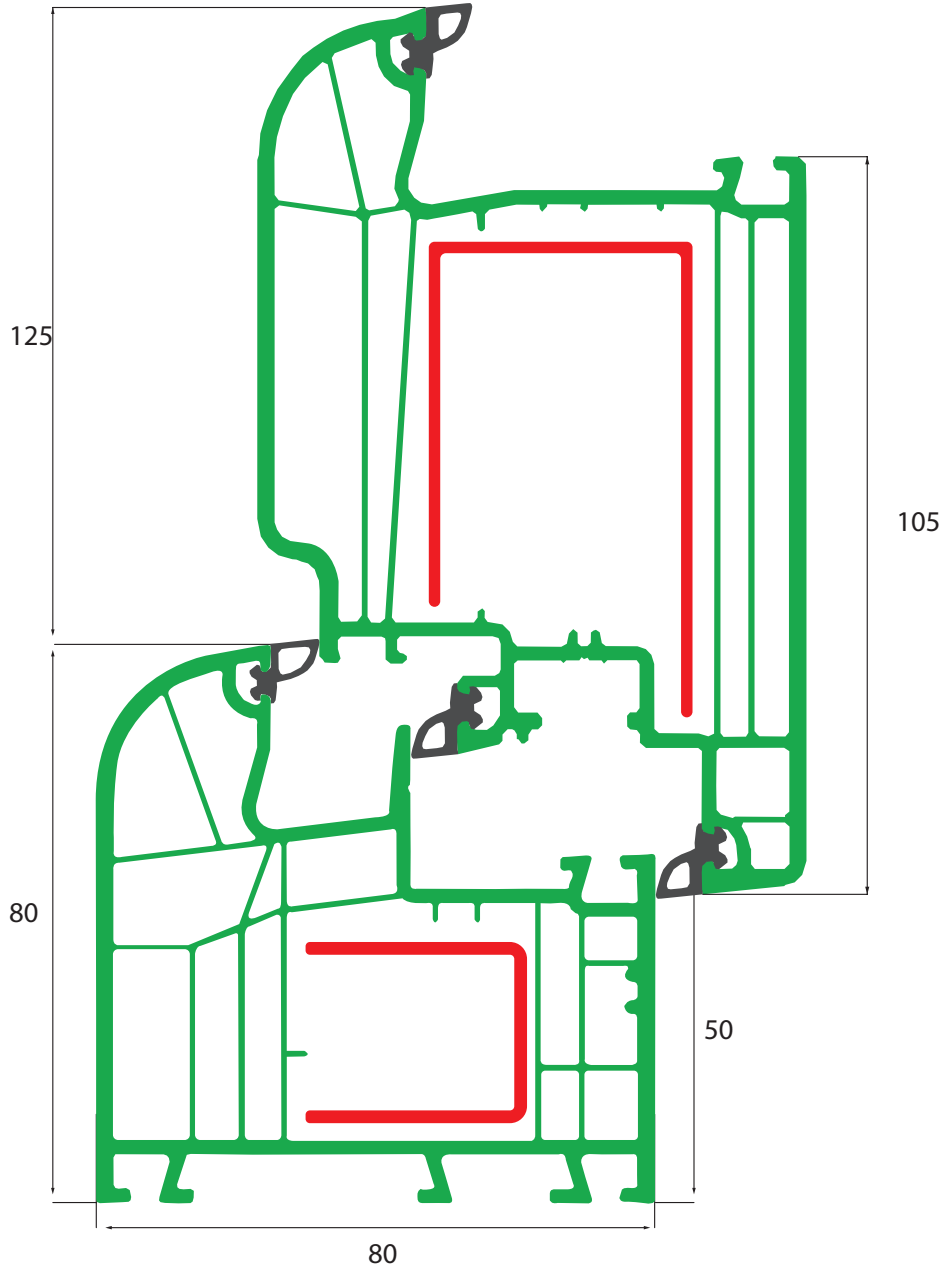
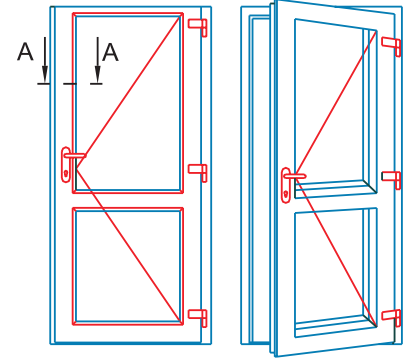



GREENWIN

PVC DOOR AND WINDOWS SYSTEM

Ortakayıt Karađı
Mullion Cover
Заглушка импоста
غطاء تي

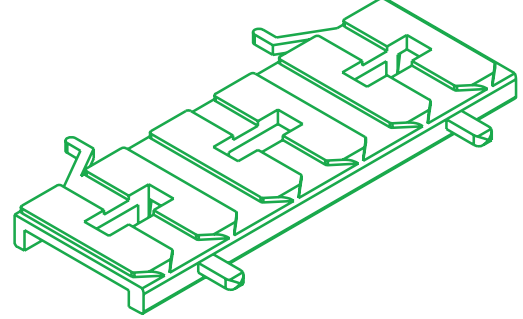
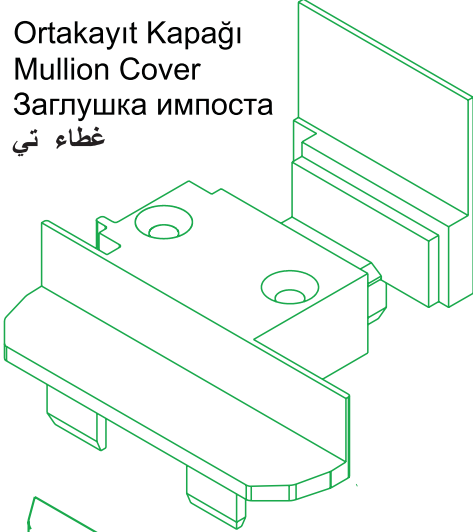

Cam Takozu
Glass Wedge (Thick)
Подкладка стеклопакета
تسميكة الزجاج

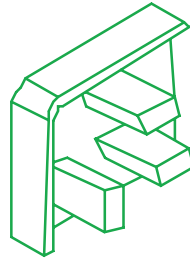

Damlalık Karađı
Cover for drainage
Крышка водоотлива
غطاء مسيل المطر

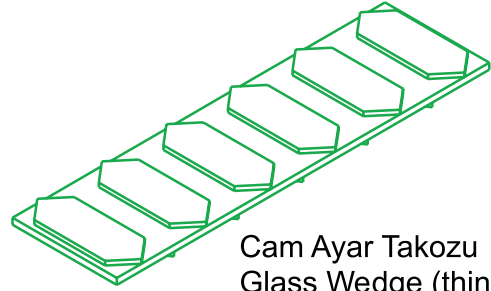

Cam Ayar Takozu
Glass Wedge (thin)
Подкладка регулировки
стеклопакета
تسميكة المعيار للزجاج

50

60x90 Pervaz Rozeti
60x90 Cornice badge
60x90 Соединитель
профиля откоса
وصلة تشبيك الكشف ٦٠x٩٠

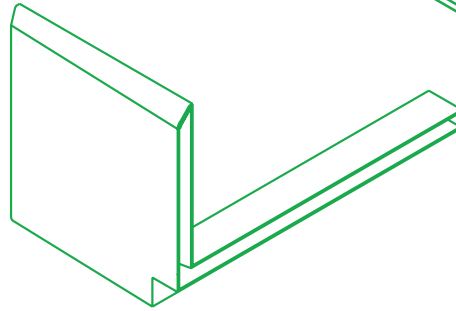
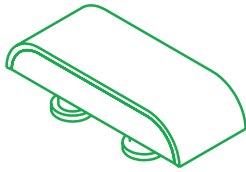

80x150 Pervaz Rozeti
80x150 Cornice badge
80x150 Соединитель
профиля откоса
وصلة تشبيك الكشف ٨٠x١٥٠

Su Tahliye Karađı
Water Discharge Plug
Крышка водостоков
غطاء تفریغ الماء

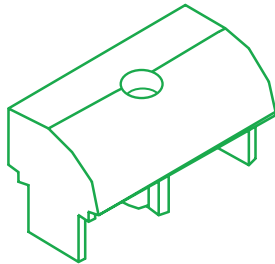

Montaj Tapası
Montage Plug
Заглушка дюбеля
غطاء التركيب

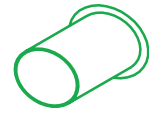

Kanat Kaldırma Takozu (Kanada Montaj)
Lifting Wedge for Sash (Mounting to Sash)
Фиксатор-балансир створки
ترفیعة الضلفة (یركب على الضلفة)

Köşe Birleřtirme Adaptörü (Pervaz)
Corner Connect Piece for Cornice
Адаптор углового соединения
بروفیل أدبتر المعدل للزاوية (كرنیش)

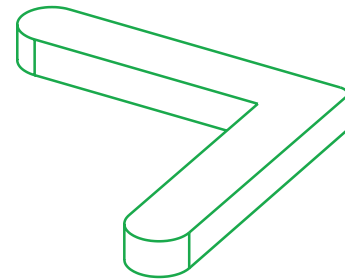

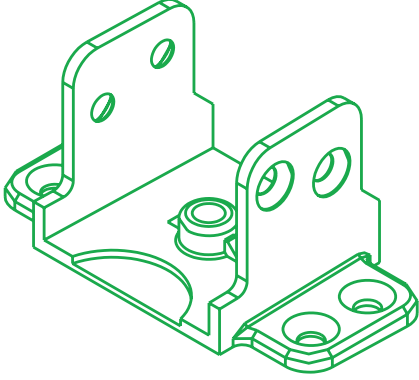

Ortakayıt Bağlantı Takozu
Mullion Fitting Wedge
Держатель импоста
لقمة لربط بروفيل تي

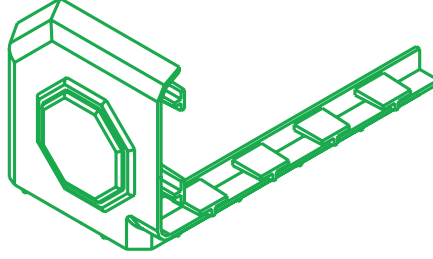

Pervaz Köşe Rozeti
Corner cornice badge
Соединитель профиля откоса
وصلة تشبيك زاوية الكشف

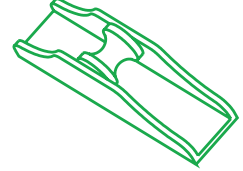

Sürme Sineklik Teker
Sliding Fly Screen wheel
Ролики для раздвижной
москитной системы
عجلة منخل السحاب

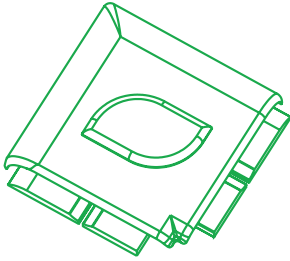

Universal Pervaz Rozeti
Universal Cornice badge
Универсальный соединитель
профиля откоса
وصلة كشف اوني وارسال

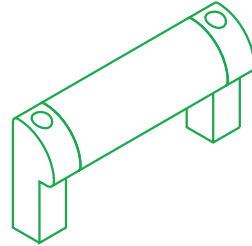

Sineklik Tutamağı
Fly Screen holder
Ручка для москитной
сетки
مسكة منخل

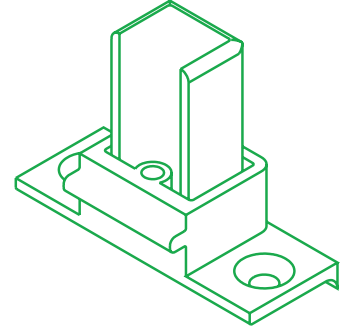

Sineklik Ortakayıt Takozu
Fly Screen mullion wedge
Держатель импоста для
раздвижной москитной сетки
لقمة تي المنخل

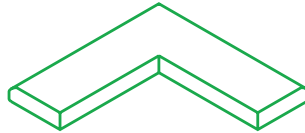

Universal Pervaz Klipsi
Universal Cornice clip
Универсальный адаптор
углового соединения откоса
زاوية كشف اوني وارسال

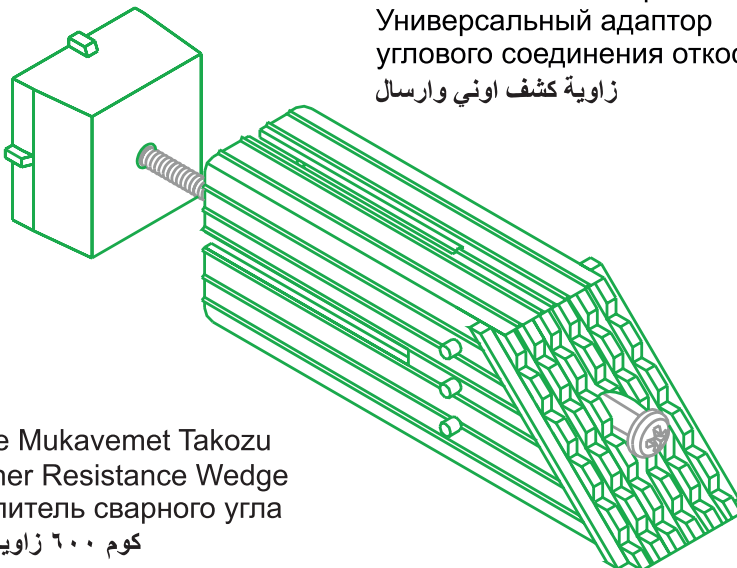

Köşe Mukavemet Takozu
Corner Resistance Wedge
Усилитель сварного угла
كوم ٦٠٠ زاوية لحام

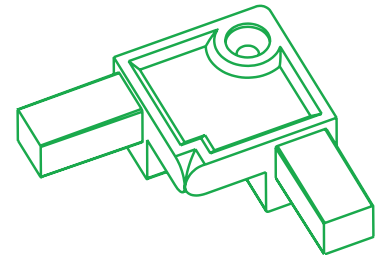

Sürme Sineklik Kasa Birleştirme
Adaptörü
Sliding Fly Screen Frame
combination adaptor
Соединительный профиль для
раздвижной москитной системы
ادبتر تشبيك سكة منخل السحاب

Yaytař Mah. Organize Sanayi Bölgesi
1. Etap 11. Sk. no: 12 Yeniřehir /DİYARBAKIR

T : +90 412 252 55 36

F : +90 412 252 55 37

info@greenwin.com.tr

www.greenwin.com.tr

